



phi.us

PRO FORUM

Air Sealing for CPHCs

WHAT AND WHY IS A BUILDING?

A successful building will:

- Keep us dry, warm or cool,
- Keep us healthy
- Provide running water, functional sewer, electricity, connectivity
- Be affordable (What a concept!?)
- Be efficient (this is last!)

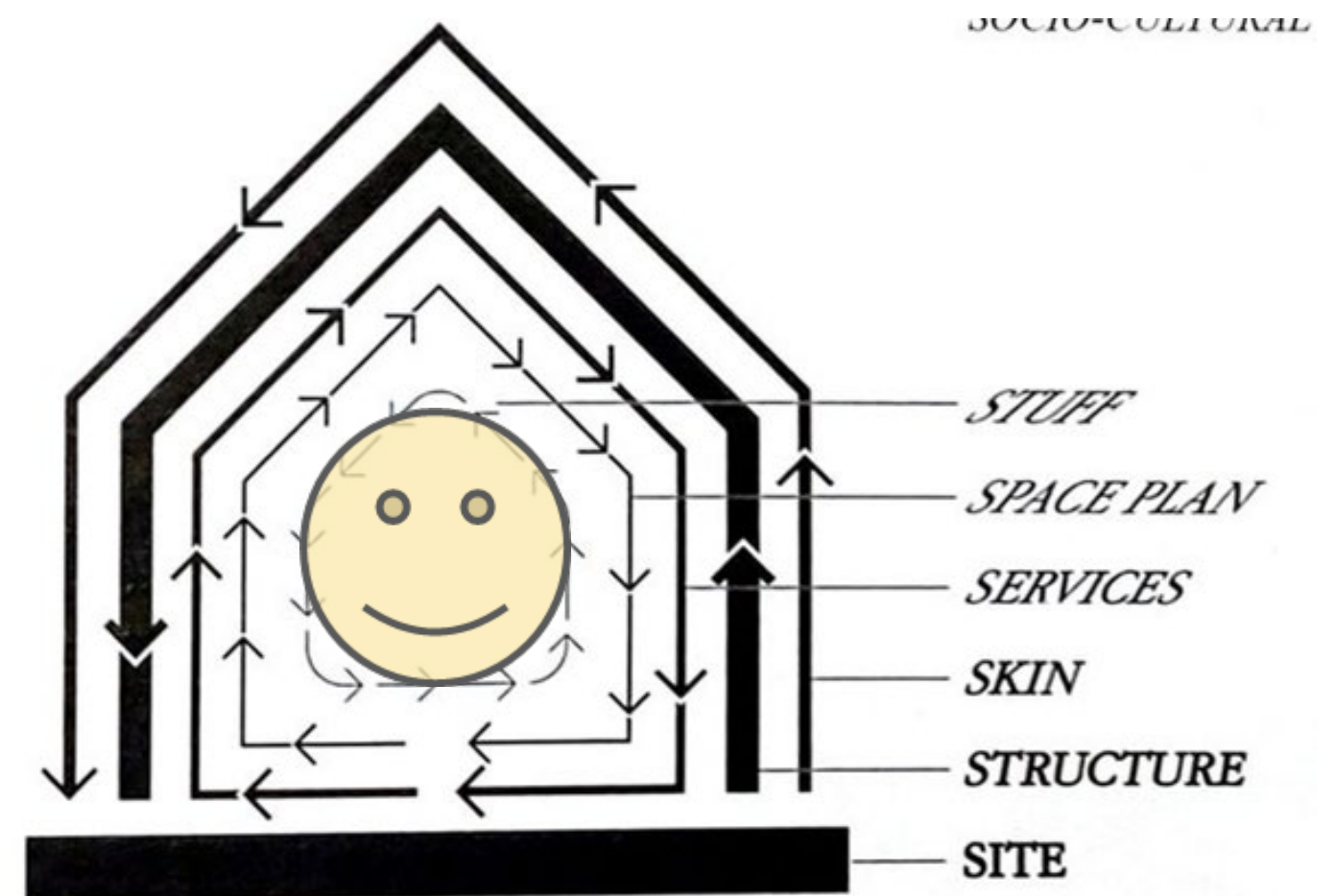

Steward Brand's shearing layers of change from How Buildings Learn

WHAT AND WHY IS A BUILDING?

A building is a structure which is built with materials to enclose a space.

A building's purpose is to provide shelter from the weather

The modern building envelope is a critical component in providing shelter: rain, snow, wind, heat, cold.



WHAT IS THE FUNCTION OF AN ENVELOPE?

Envelope Function (for today):

- Control: to control, block, regulate and/or moderate all the loadings due to the separation of the interior and exterior environments. This largely means the flow of mass (**AIR**, moisture, etc.) and energy.
- Exfiltration, infiltration, stack effect, wind effect, even mechanical systems

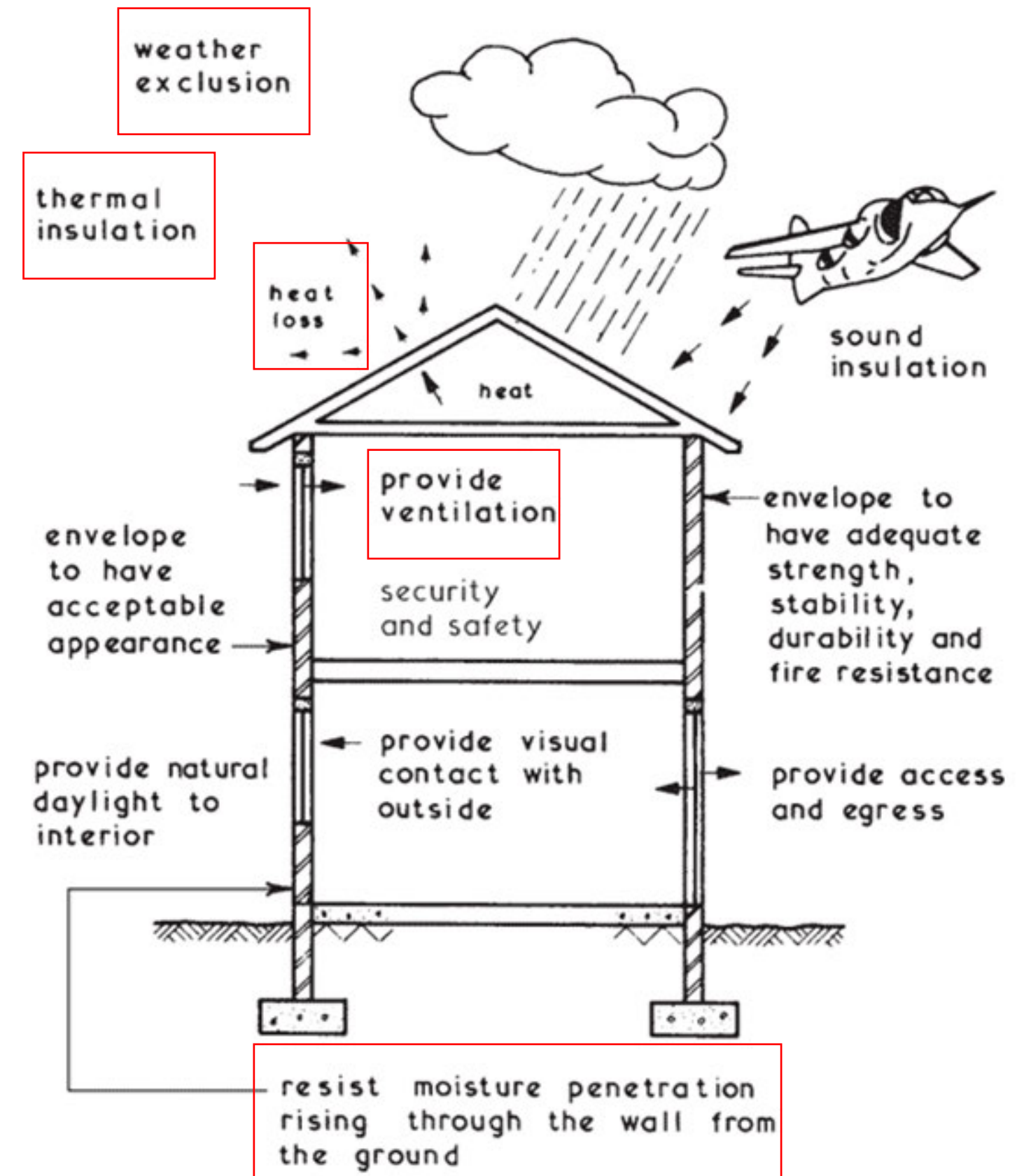

WHY DO WE CONTROL AIR FLOW?

Good Air Control will:

- Minimize pollutants and allergens
- Eliminate condensation from exfiltration (cold climates) and infiltration (hot climates)
- Avoid structural corrosion (rot), mold growth, durability issues
- Minimize energy losses

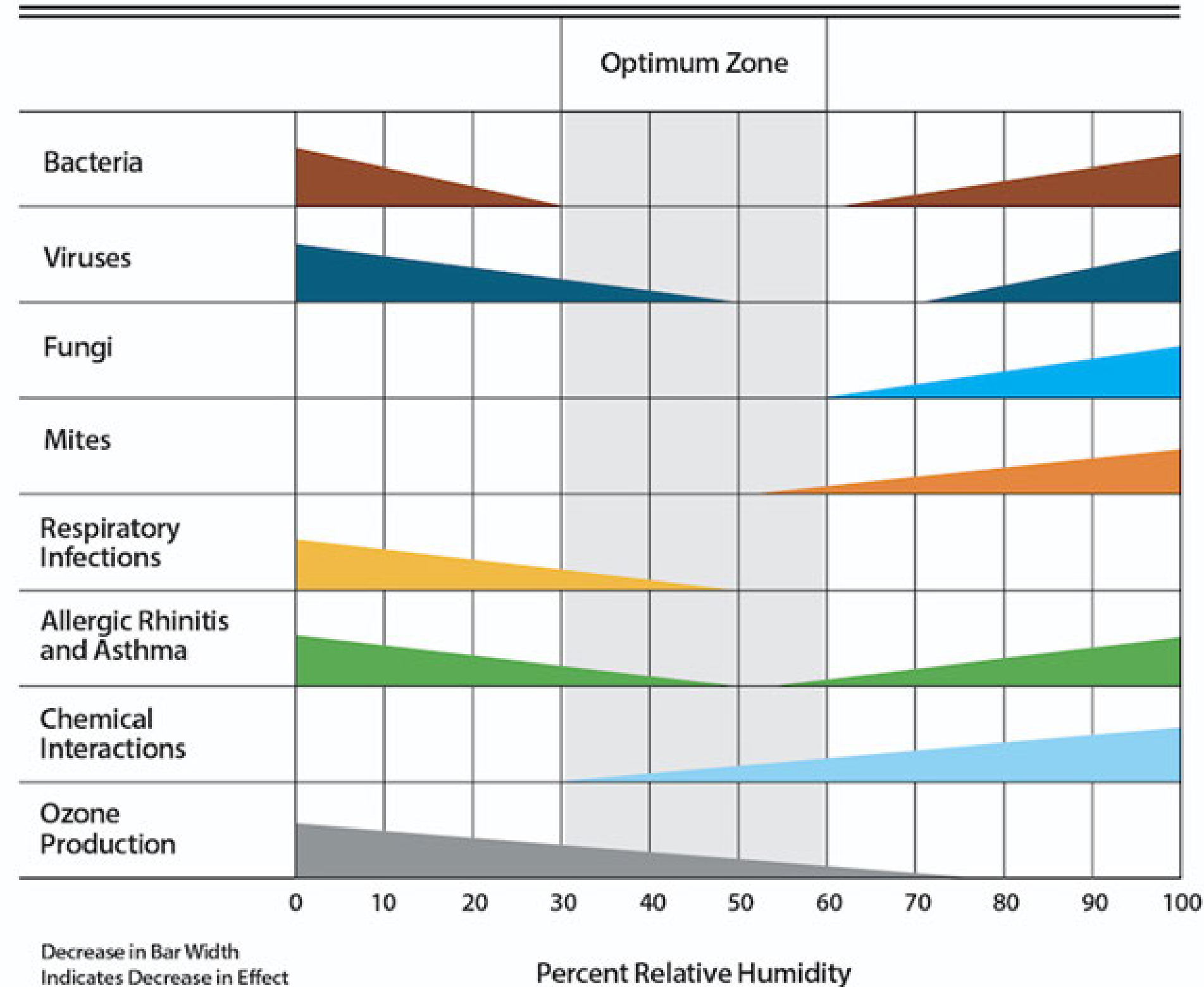

HOW DOES AIR MOVE?

Air only moves if:

- A pressure difference exists
- A pathway is available

Air moves from higher pressure to lower pressure – always!

Is there a pressure difference?
Is there a pathway?

Is there a pressure difference?
Is there a pathway?



AIR BARRIER - DEFINITION

Air Barrier Association of America (ABAA) :

- An “air barrier” is a combination of materials designed and installed in such a manner to **drastically reduce or even stop** the flow of air into and through the building enclosure.
- The air barrier of a building is an “air barrier **system**”. The air barrier system is comprised of “air barrier *assemblies*”. Air barrier assemblies are comprised of “air barrier *materials*” and air barrier *accessories*.
- The function is to control both infiltration and exfiltration of air through the enclosure.



AIR BARRIER CHARACTERISTICS

Continuity

- Critically important and must be considered in 3D

Strength

- Needs to be able to withstand loads: wind, stack effect, mechanical systems

Rigidity

- Resistance to deformation due to changing pressures exerted on a building

Durability

- How long will it last and how easily it can be replaced

(Im)permeability

- For materials: ≤ 0.004 cfm/ft² @ 75 Pa. in accordance with ASTM E2178
- For assemblies: ≤ 0.04 cfm/ft² @ 75 Pa in accordance with ASTM E2357-18 and others

AIR BARRIER MATERIALS

Concrete

- Structural, cast-in-place, is (generally) acceptable.
- Thinner slabs (like a 'rat slab') or unreinforced flatwork is risky at best.
- CMU, even with grouted cores, is still very porous.



Wood Products

- Engineered wood members such as LVL, PSL, CLT are generally airtight
- Commodity OSB vs engineered sheet good (plywood, "AdvanTech")



AIR BARRIER MATERIALS

GWB

- Used frequently for unit compartmentalization: easier leakage thresholds
- Can be complicated to ensure continuity and requires a lot of attention to detail for success

Applied Products

- Liquid or self-adhered (peel and stick) sheet applied membranes, tapes, sealants
- Foam (?), cellulose (?)
- Wrap product are not sufficient

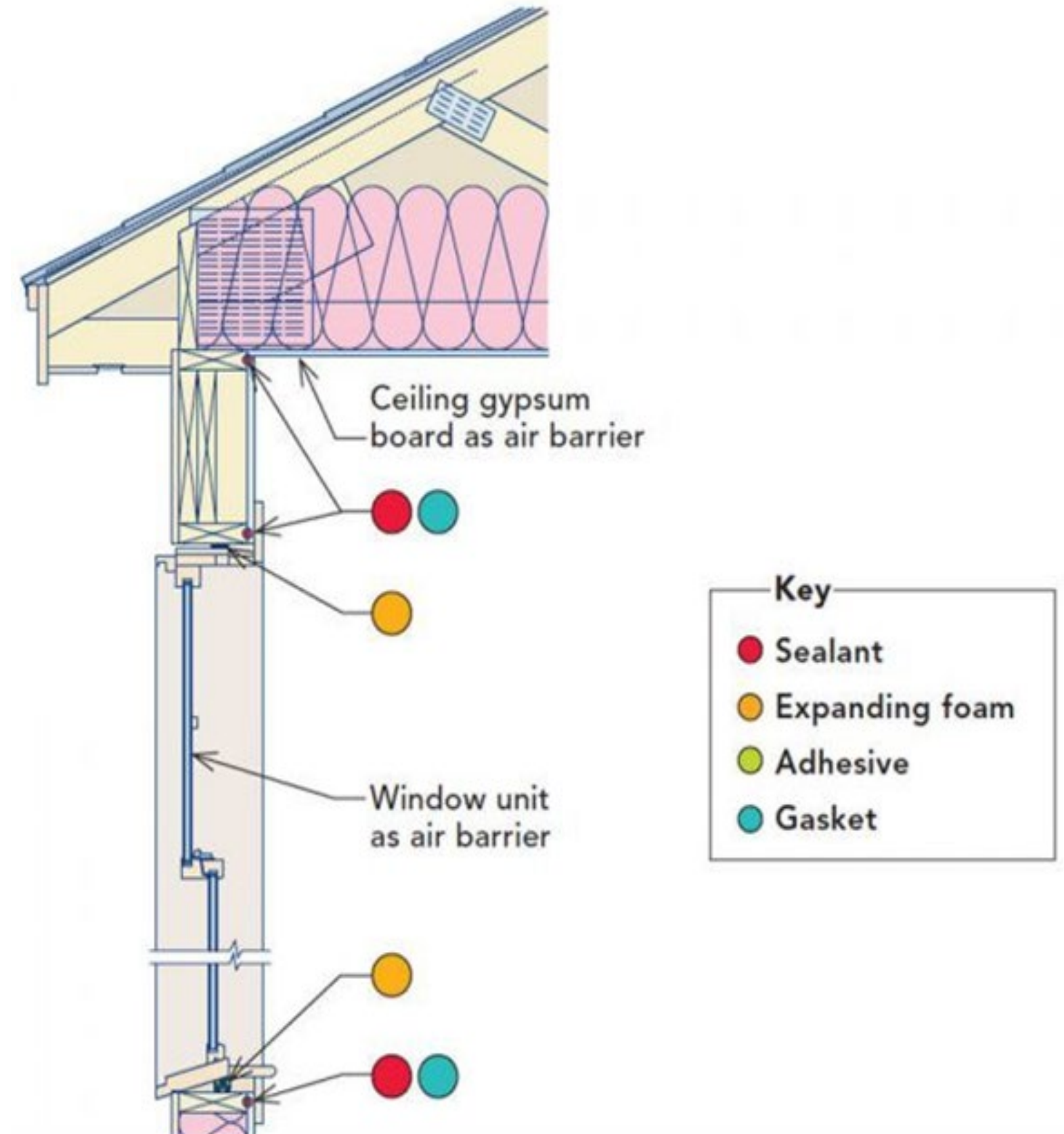

AIR SEALING...

... Is a Planning, Coordination, and Communication Task

NOTICE TO ALL SUBCONTRACTORS

1. All penetrations between the building zones and the exterior (ceiling, slab, walls, etc.) must be approved by the general contractor's designated air sealing coordinator and project architect.
2. Subcontractors are responsible for sealing any penetrations created by the installation of their building system/components and must use sealing methods pre-approved by the general contractor's air sealing coordinator and project architect.
3. Subcontractors will be held accountable for the cost of repairing any unapproved and/or improperly sealed penetration through the building's air barrier system.

AIRTIGHT BUILDING



**NO DRILLING
AIRTIGHT
CONSTRUCTION**



**NO CUTTING
AIRTIGHT
MEMBRANES**

REPORT ALL PENETRATIONS TO SUPERVISOR



AIR SEALING...

... Is About Critical Connections and Transitions

- Foundation to framed wall
 - Podium
- Wall details: corners, overhangs
- Fenestrations
- Wall to roof
- Penetrations
- Exclusions from PH air barrier
 - Central trash rooms
 - Central laundry? Not Really but Maybe...?

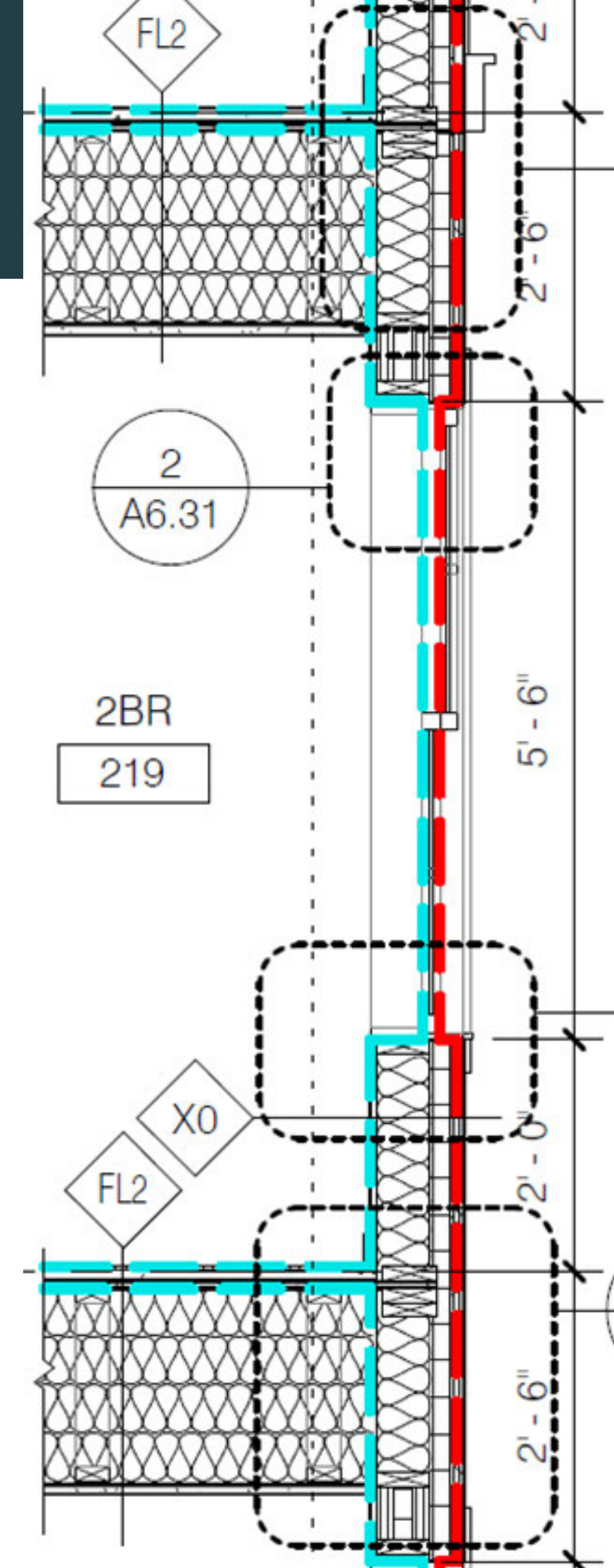
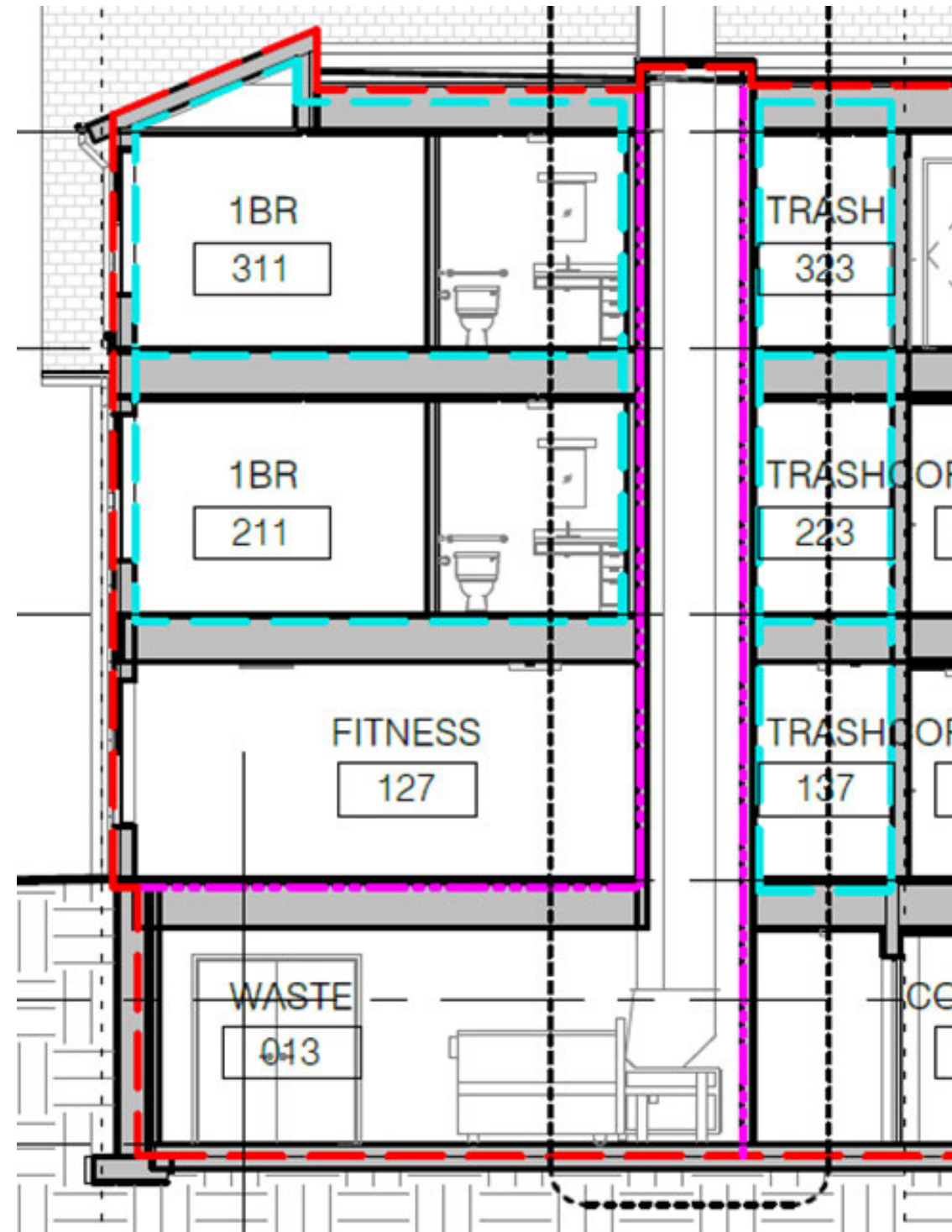

AIR SEALING...FOUNDATION TO WALL

- Vapor barrier over stem wall
 - Turn down
- Permeable WRB on CMU or sheathing
- Use tape to connect foundation to sheathing
 - Create a 'tub'

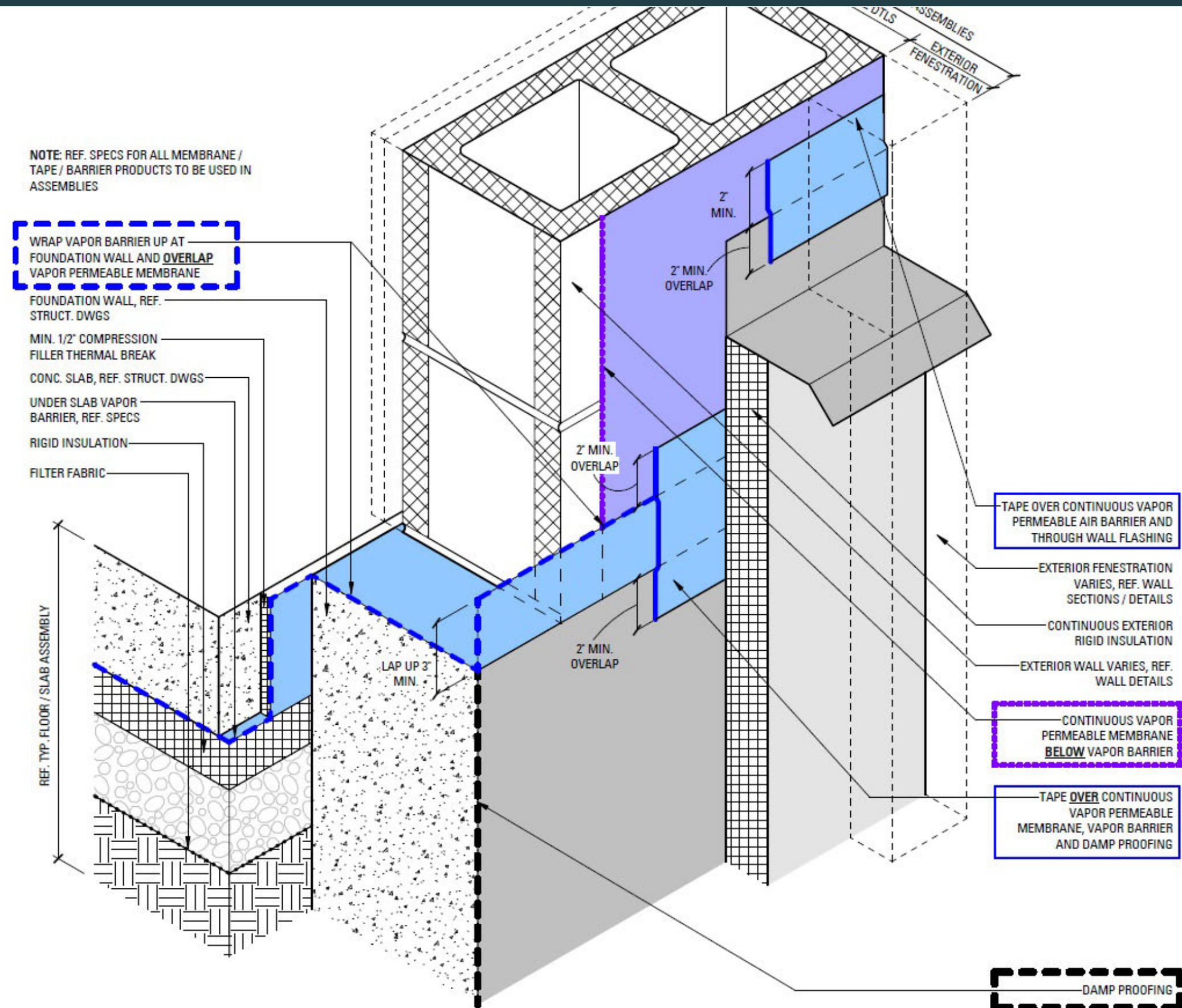

AIR SEALING: FOUNDATION TO WALL

- Vapor barrier over stem wall
 - Turn down
- Permeable WRB on CMU or sheathing
- Use tape to connect foundation to sheathing
 - Create a 'tub'

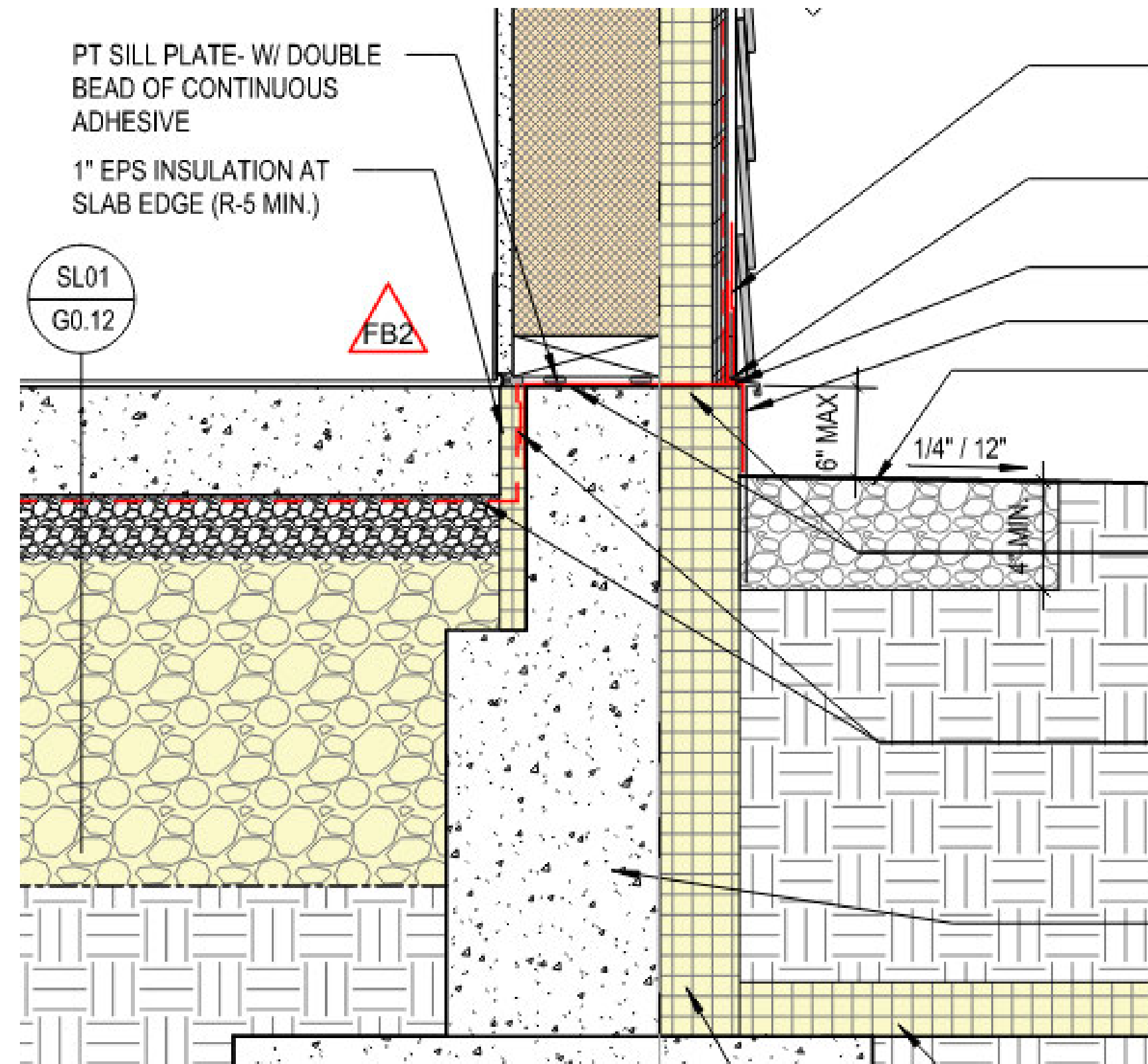

AIR SEALING: FOUNDATION TO WALL



AIR SEALING: FOUNDATION TO WALL



AIR SEALING: FOUNDATION TO WALL



AIR SEALING: FOUNDATION TO WALL



There are different products for sealing the vapor barrier. Conduit and plumbing penetrations require coordination.

AIR SEALING: PODIUM

- 1" insulation at slab edge
- Sheathing with WRB extends below steel beam
- CCSF fills cavity

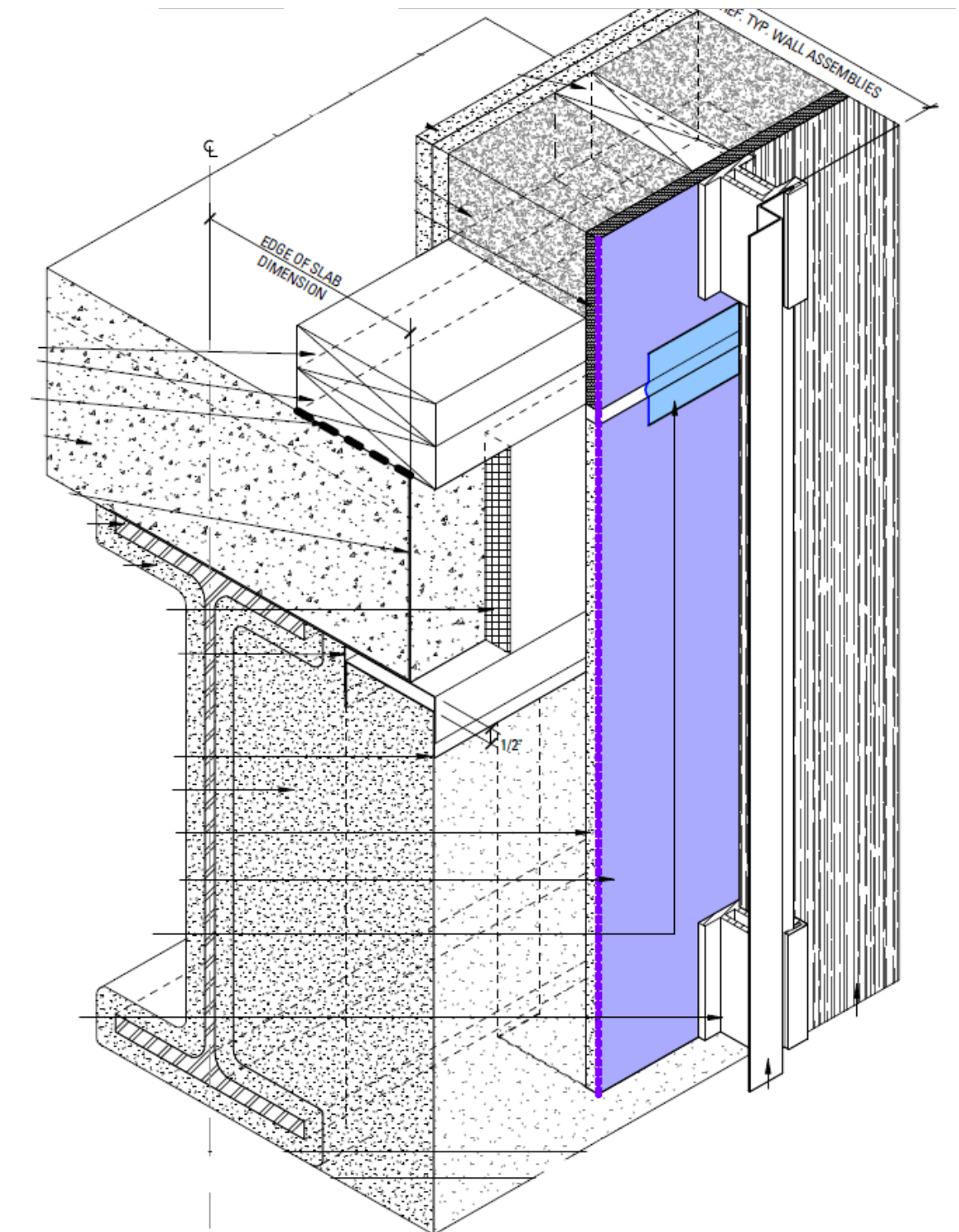
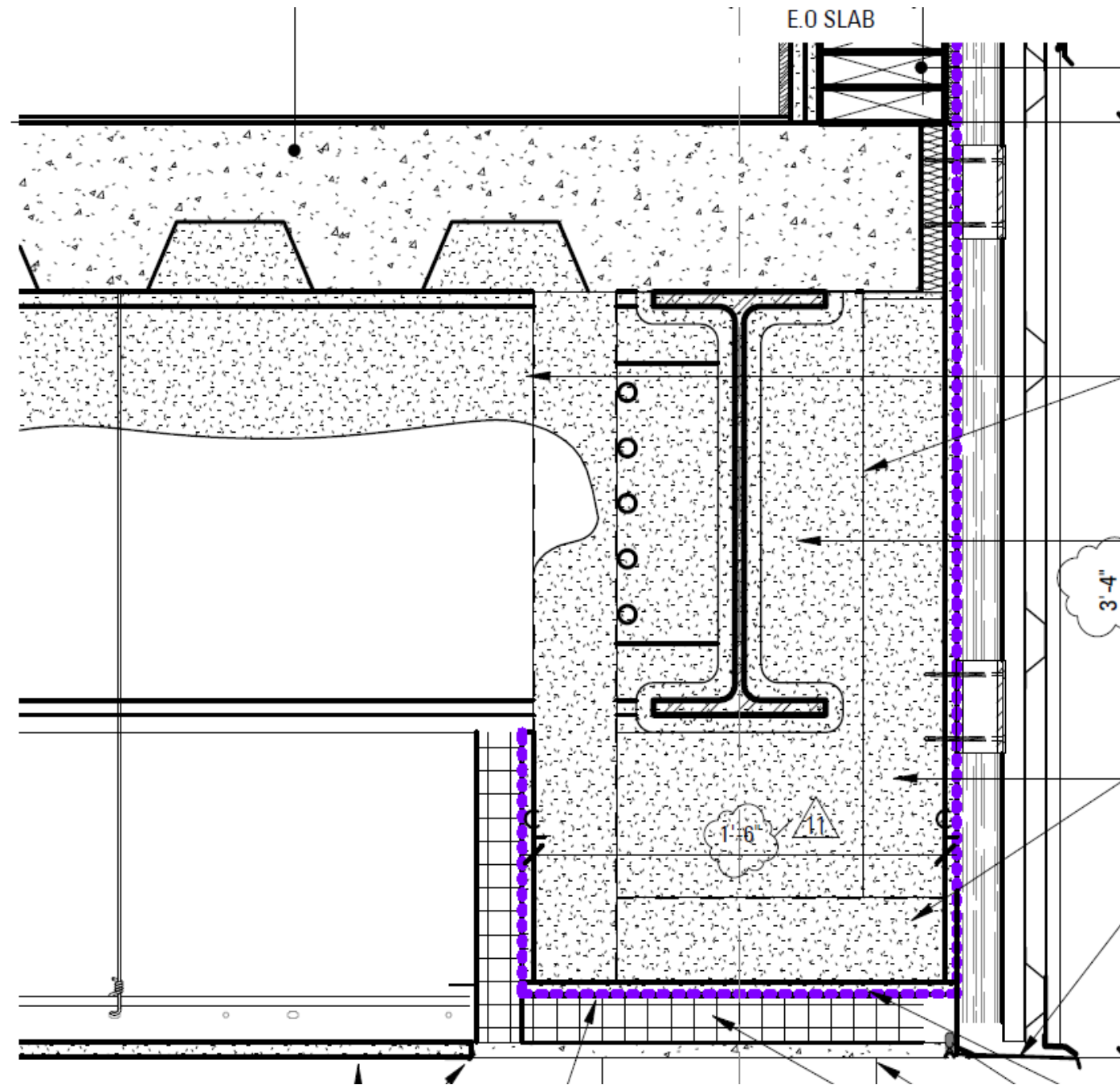

AIR SEALING: PODIUM



AIR SEALING: PODIUM

Air sealing requires planning for compartmentalization boundary's relationship to the orientation of spanning decks

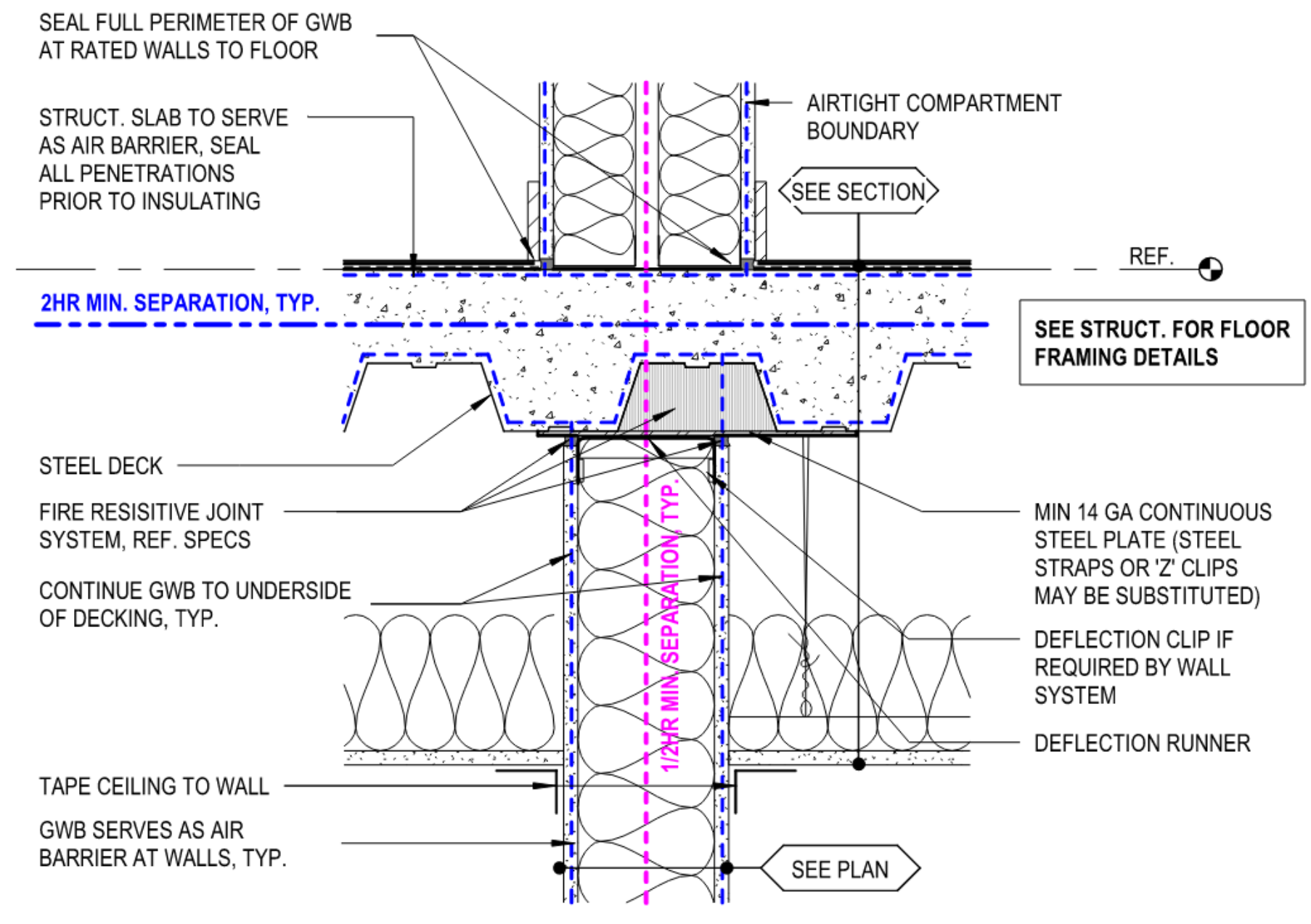
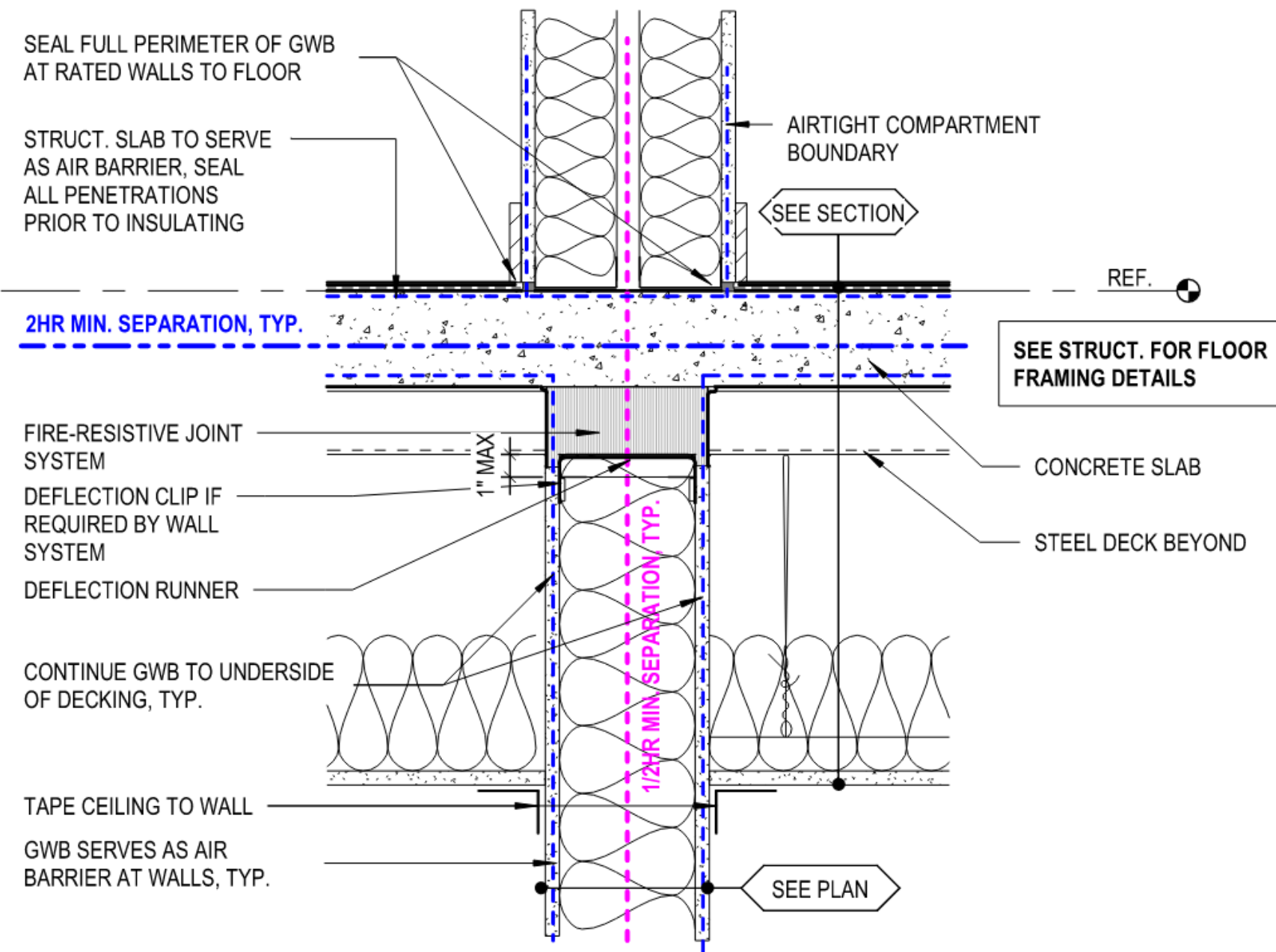

AIR SEALING: PODIUM

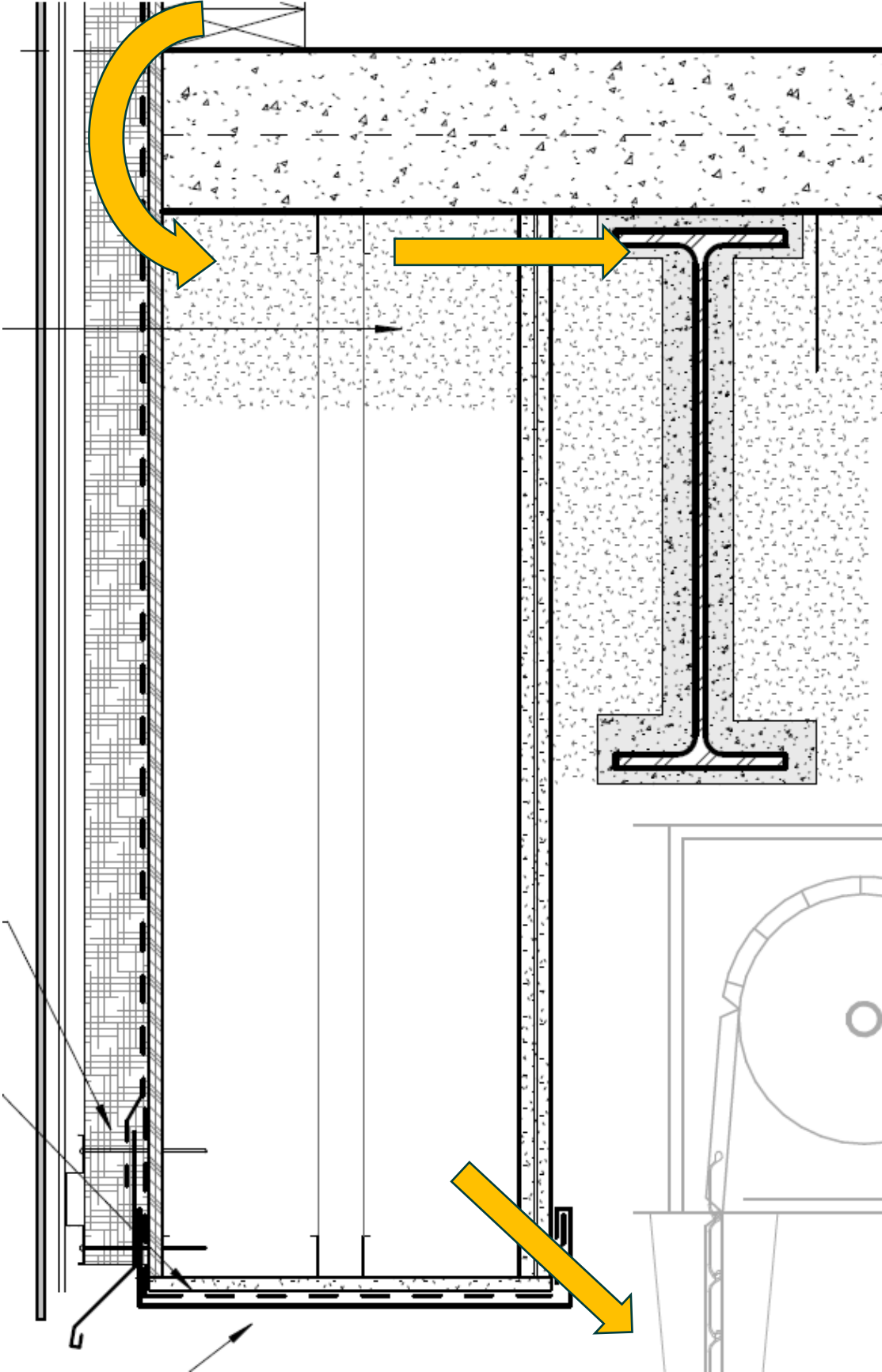
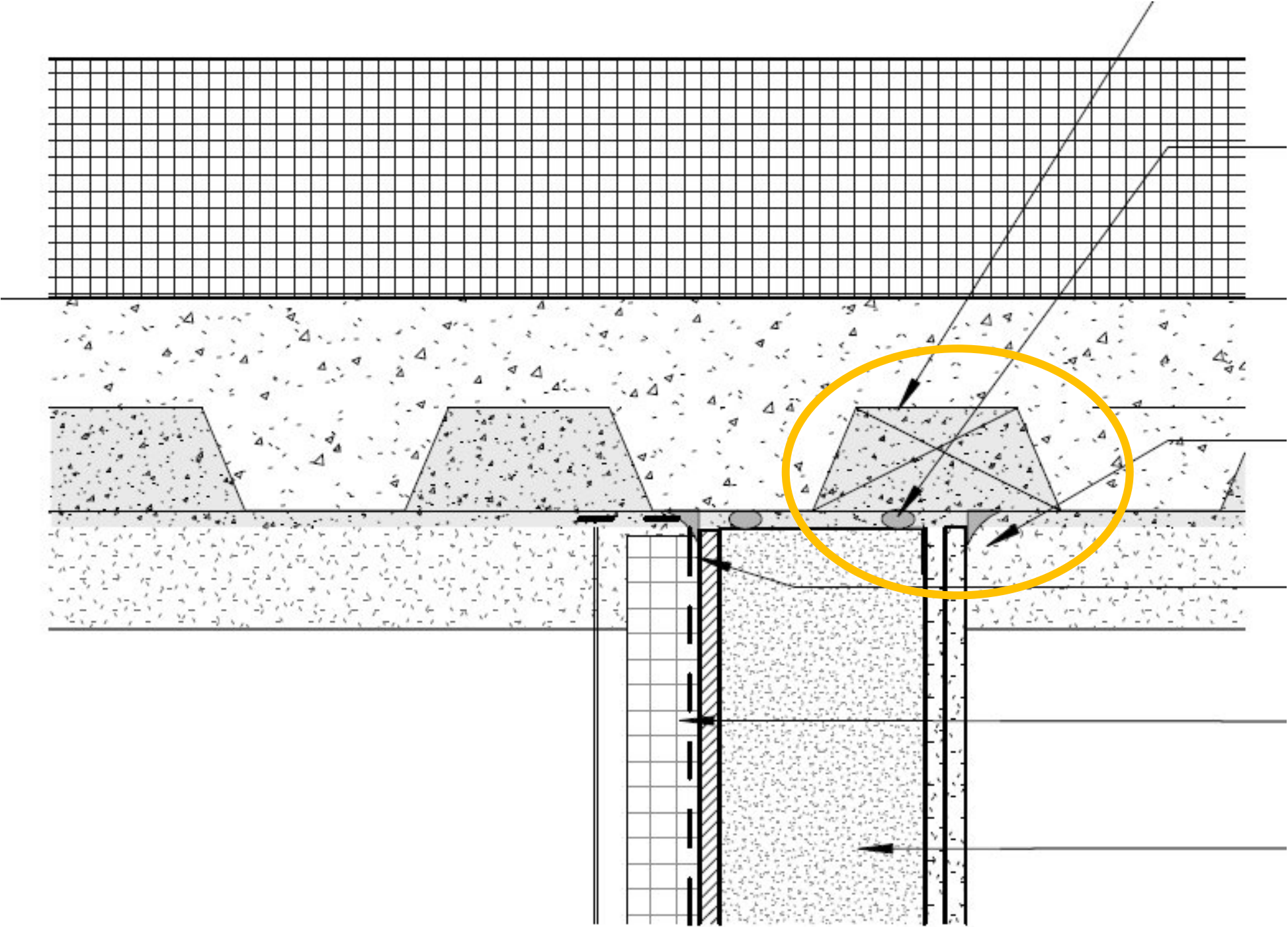

AIR SEALING: PODIUM

Corrugated steel deck sealing options

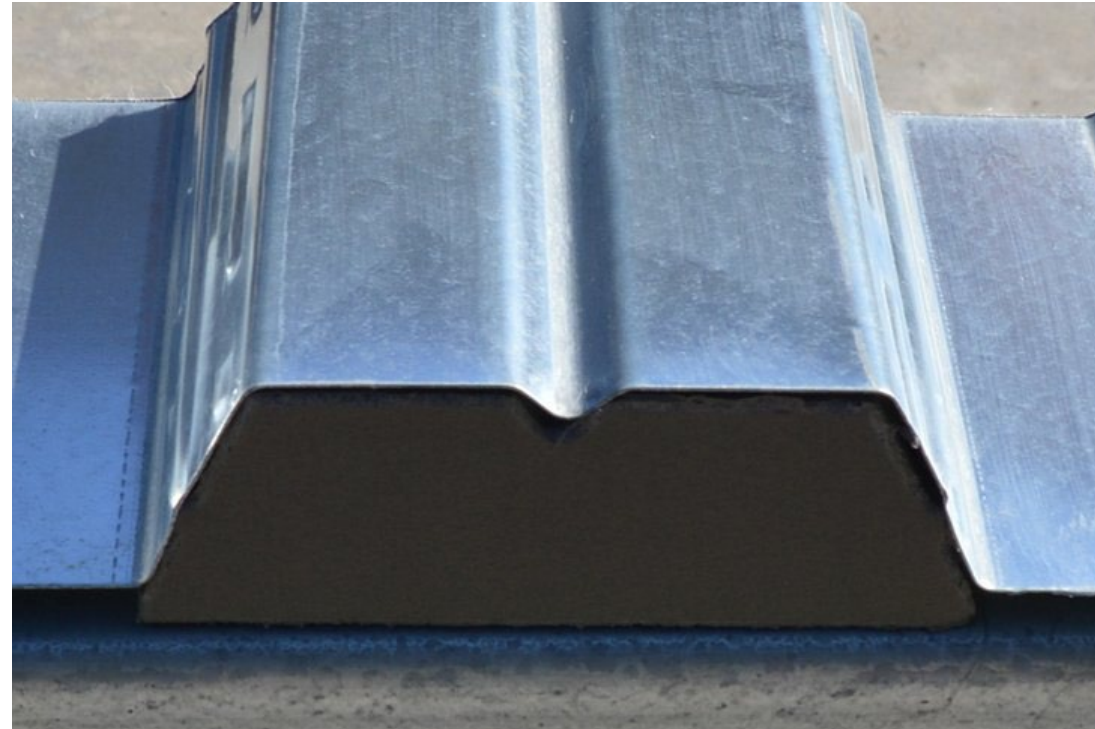
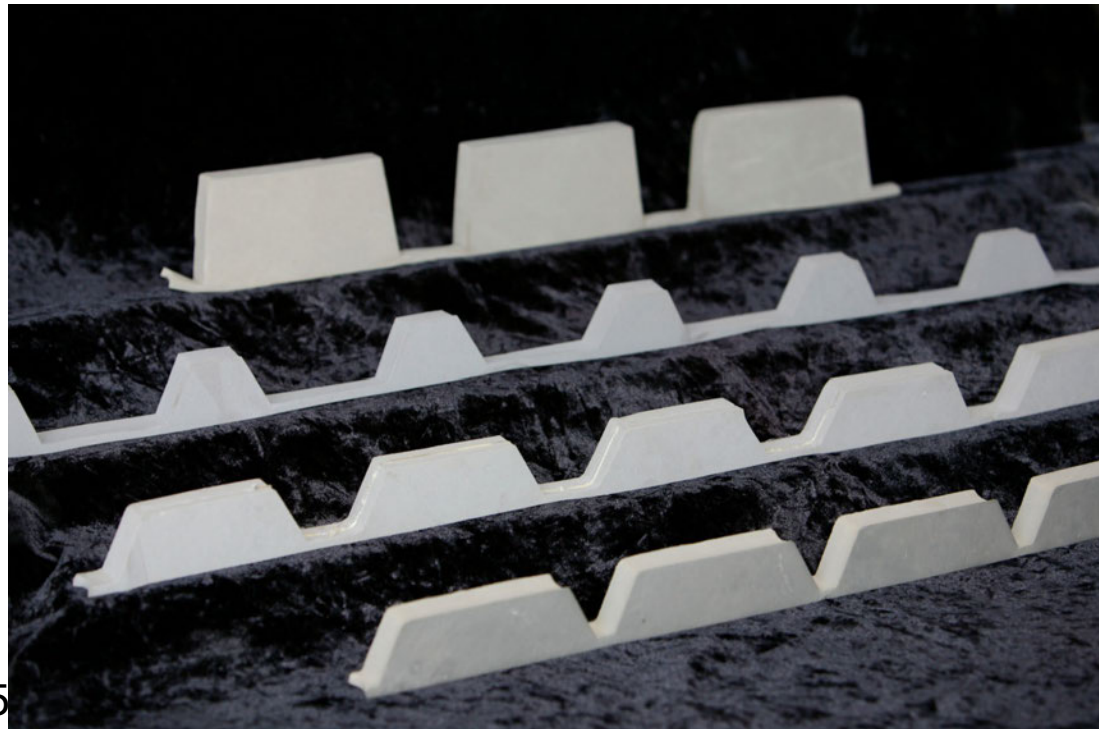

AIR SEALING: PODIUM

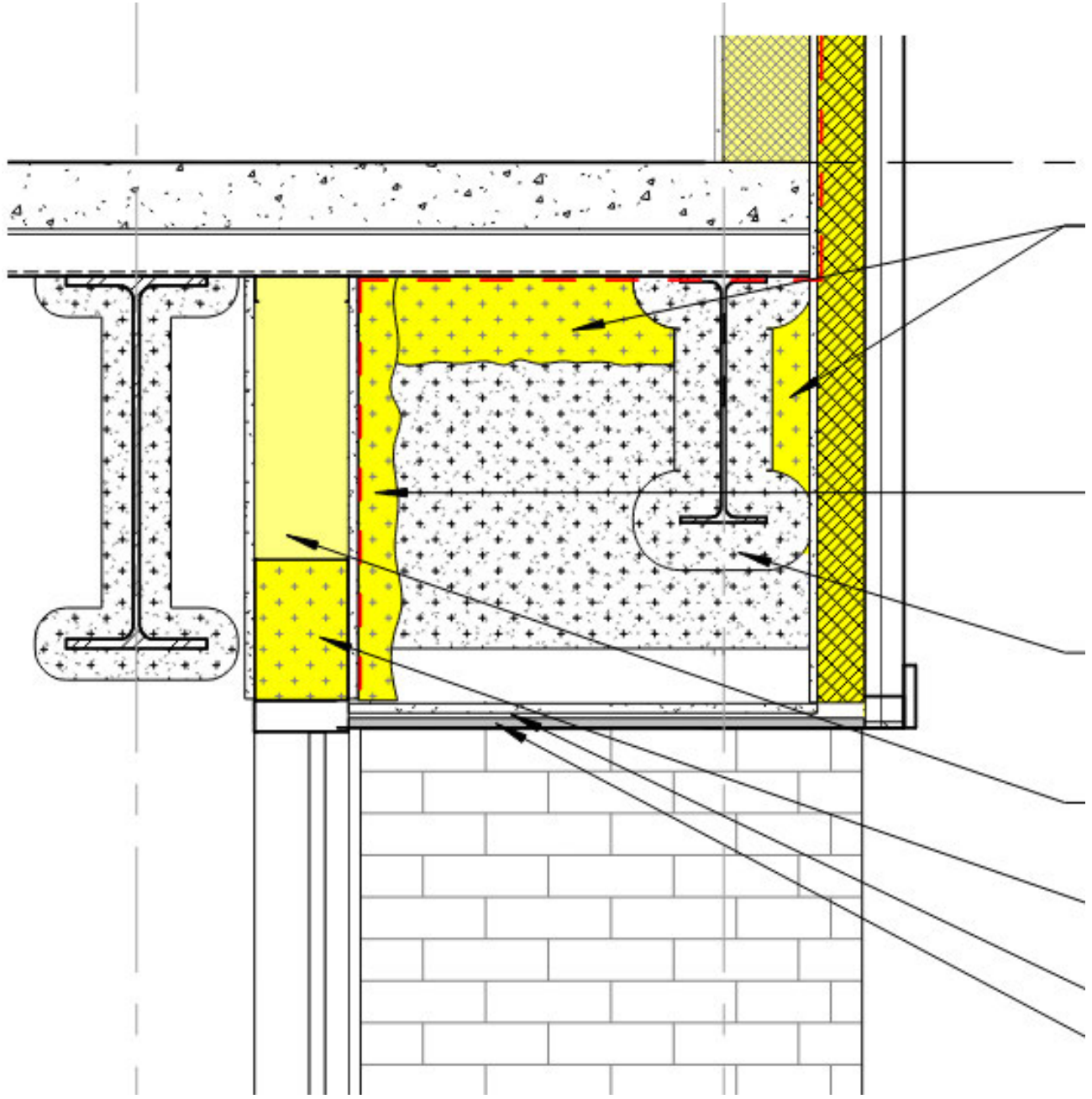
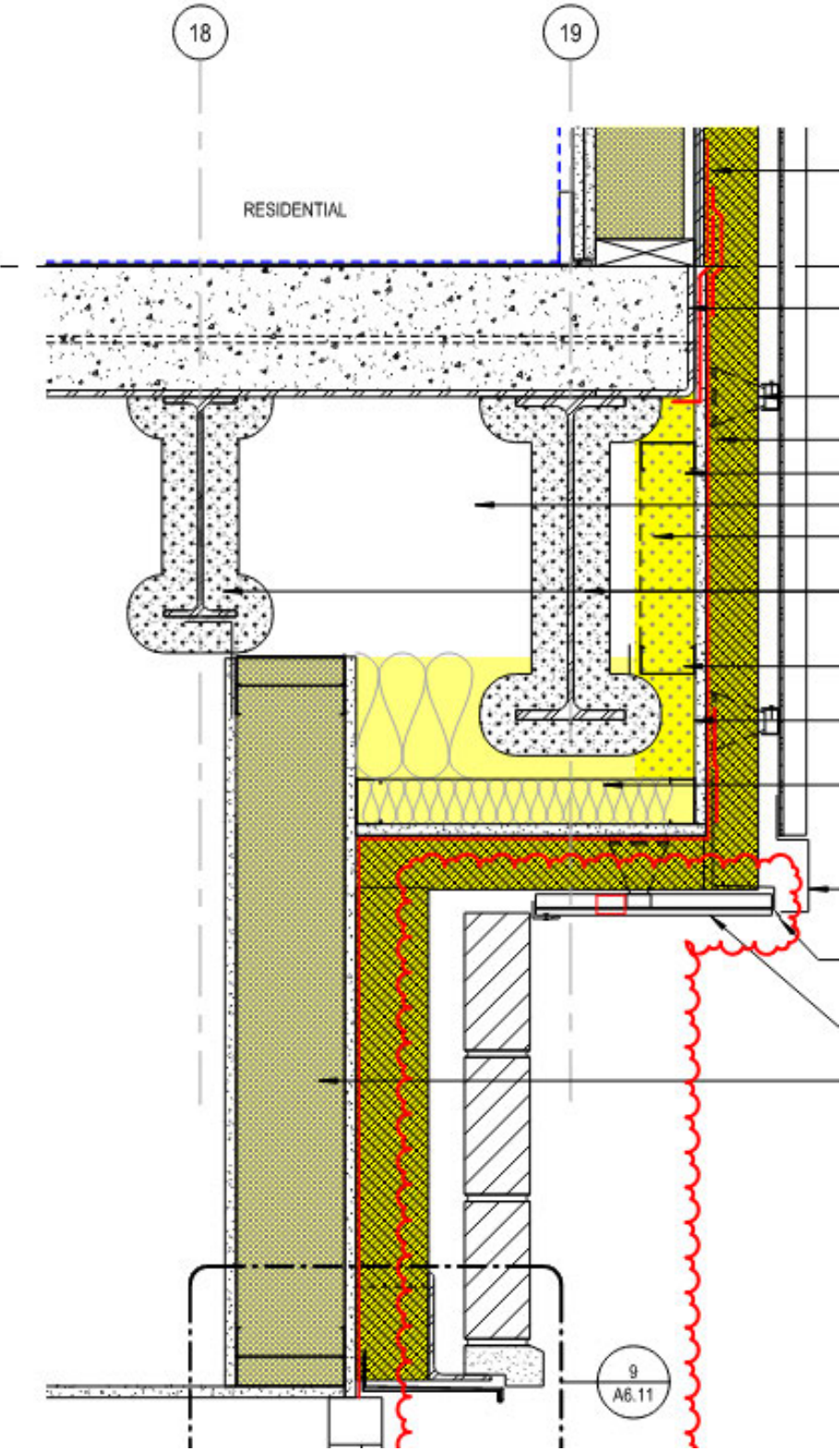

AIR SEALING: WRB

Many options available, each with own pros and cons

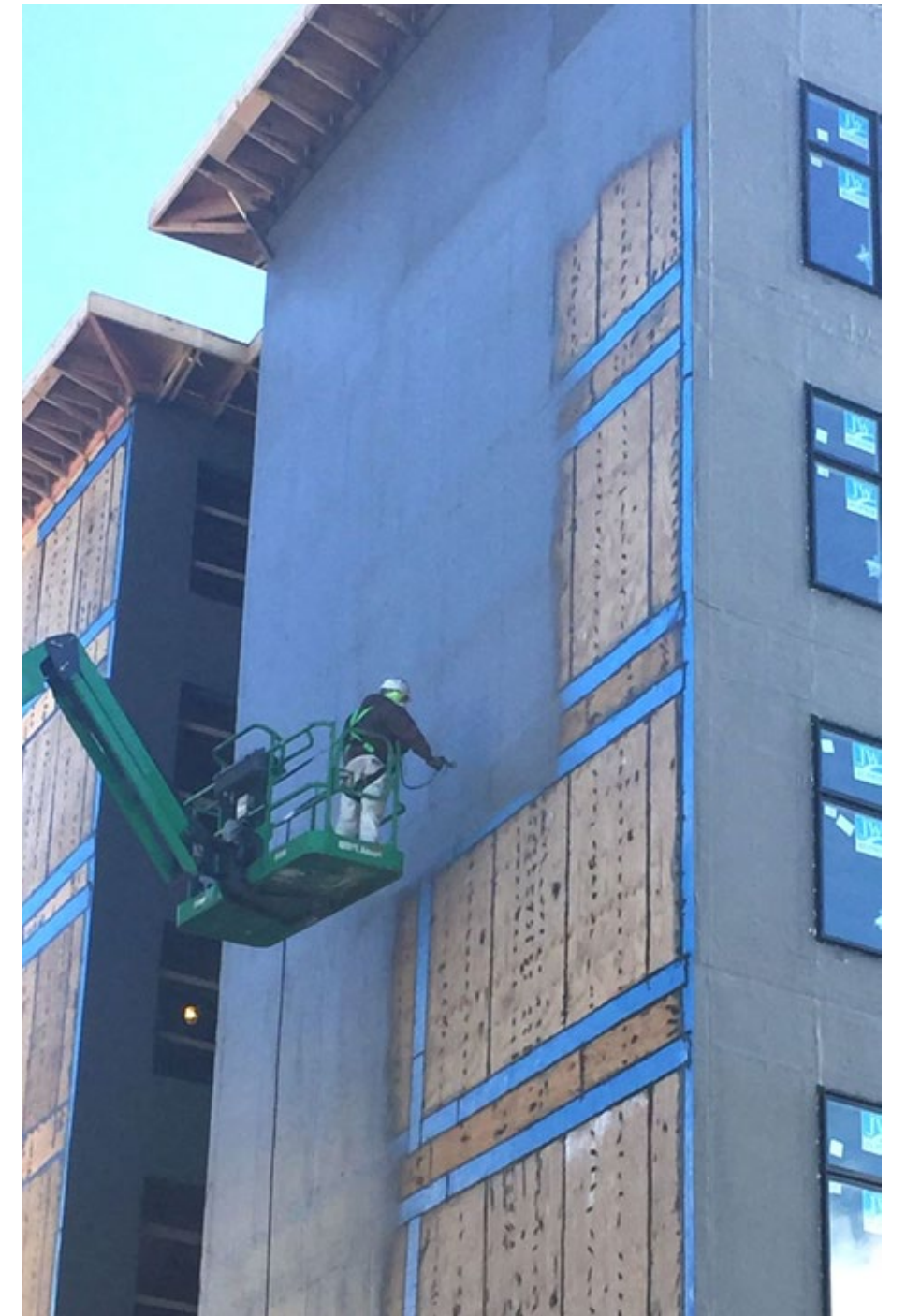

AIR SEALING: WRB

- "Overdriven" Nails
- Required sealing all nail penetrations due to definition of overdriven
- Look for "Zs"



AIR SEALING: WRB

- More extensive repairs to damaged areas
- Outside and (especially) inside corners difficult
- Typically, lower cost
- Available with integrated insulation up to R12.6



AIR SEALING: WRB

- Poor adhesion (typically environmental)
- Tares (although generally durable)
- Spans misaligned sheathing/panels well
- Minimizes tape

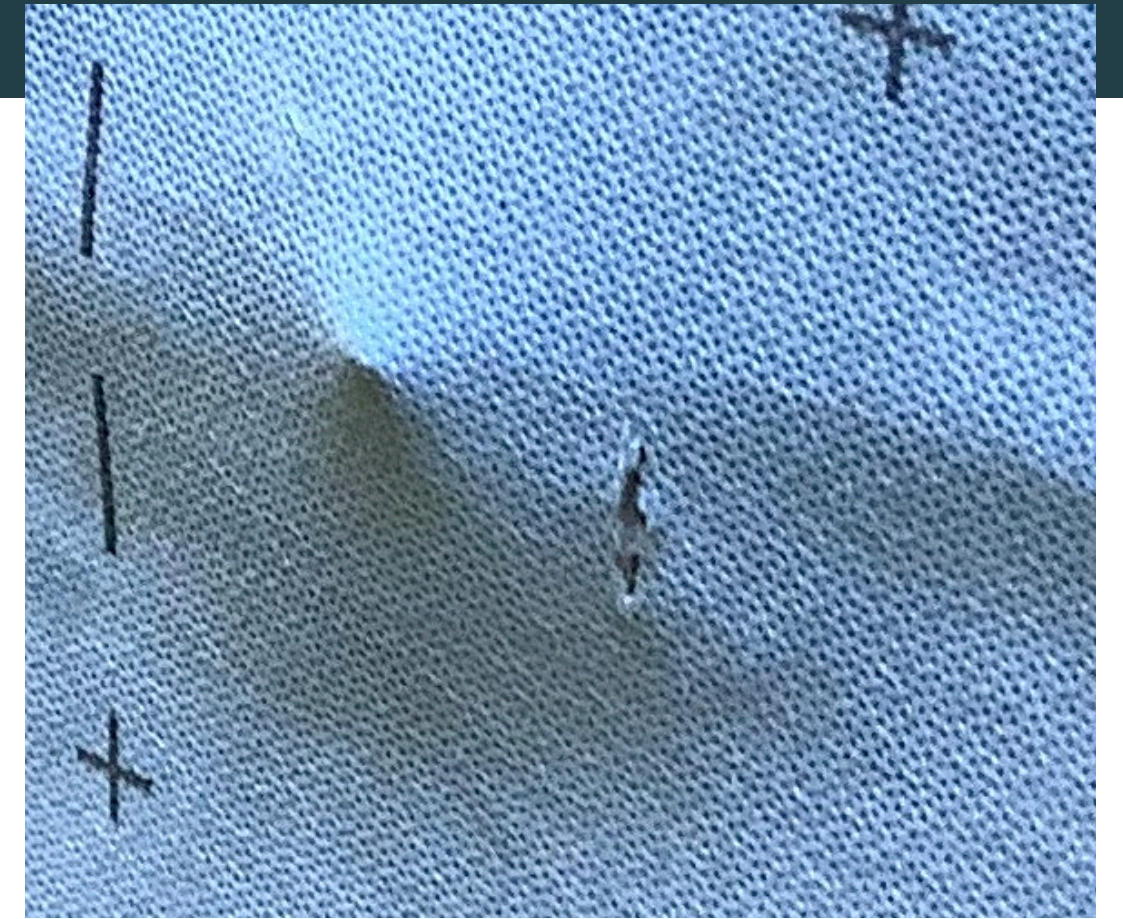

AIR SEALING: WRB

- Great on masonry (compactor room)
- Gaps must be taped
- More difficult to QC

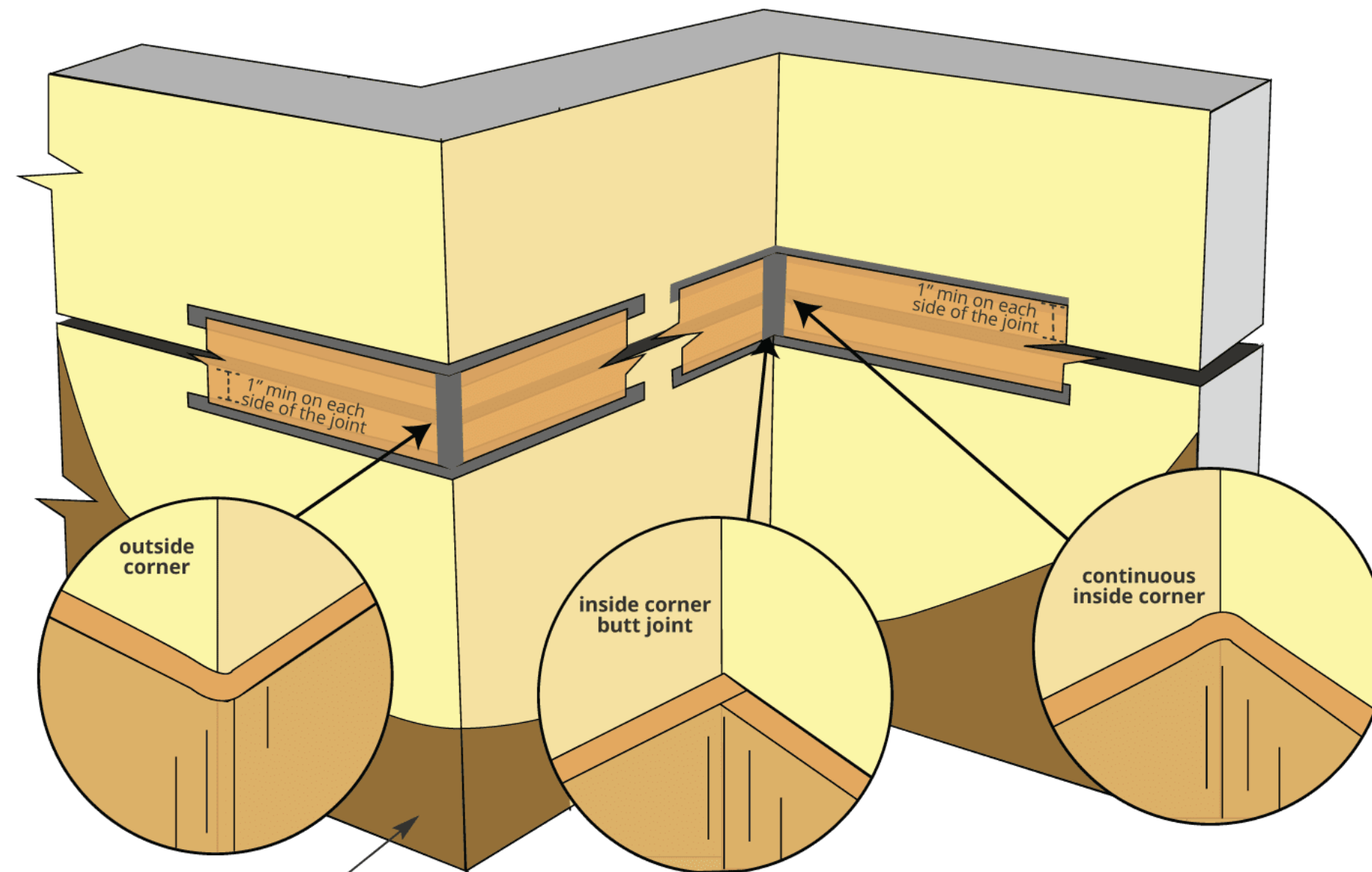

the selected PROSOCO primary Air & Water-Resistive Barrier

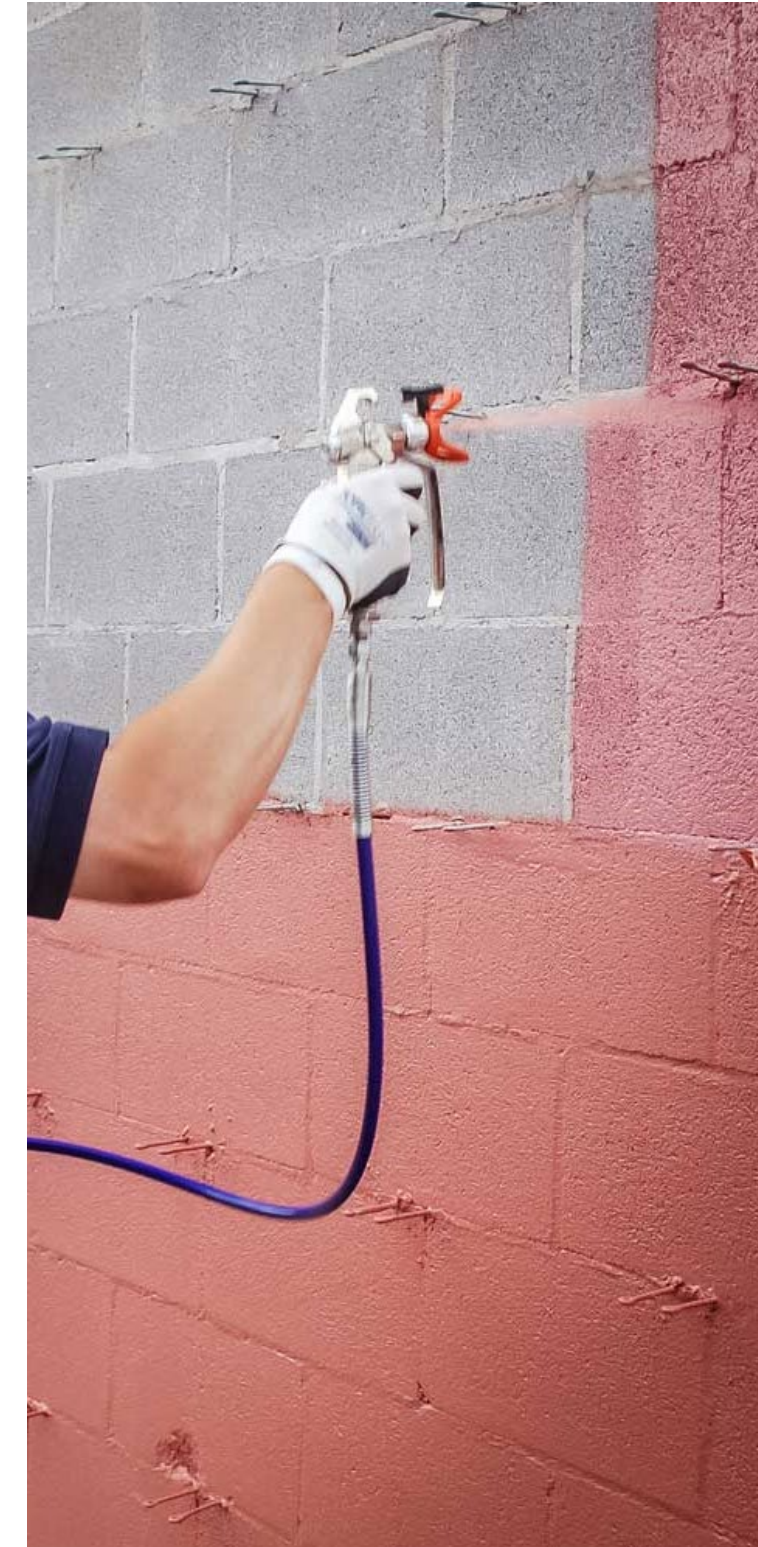

AIR SEALING: WALLS

- ZIP sheathing continuous exterior air & weather barrier
- Bottom chord bearing trusses for overhang
- Closed-cell spray foam creates interior air barrier

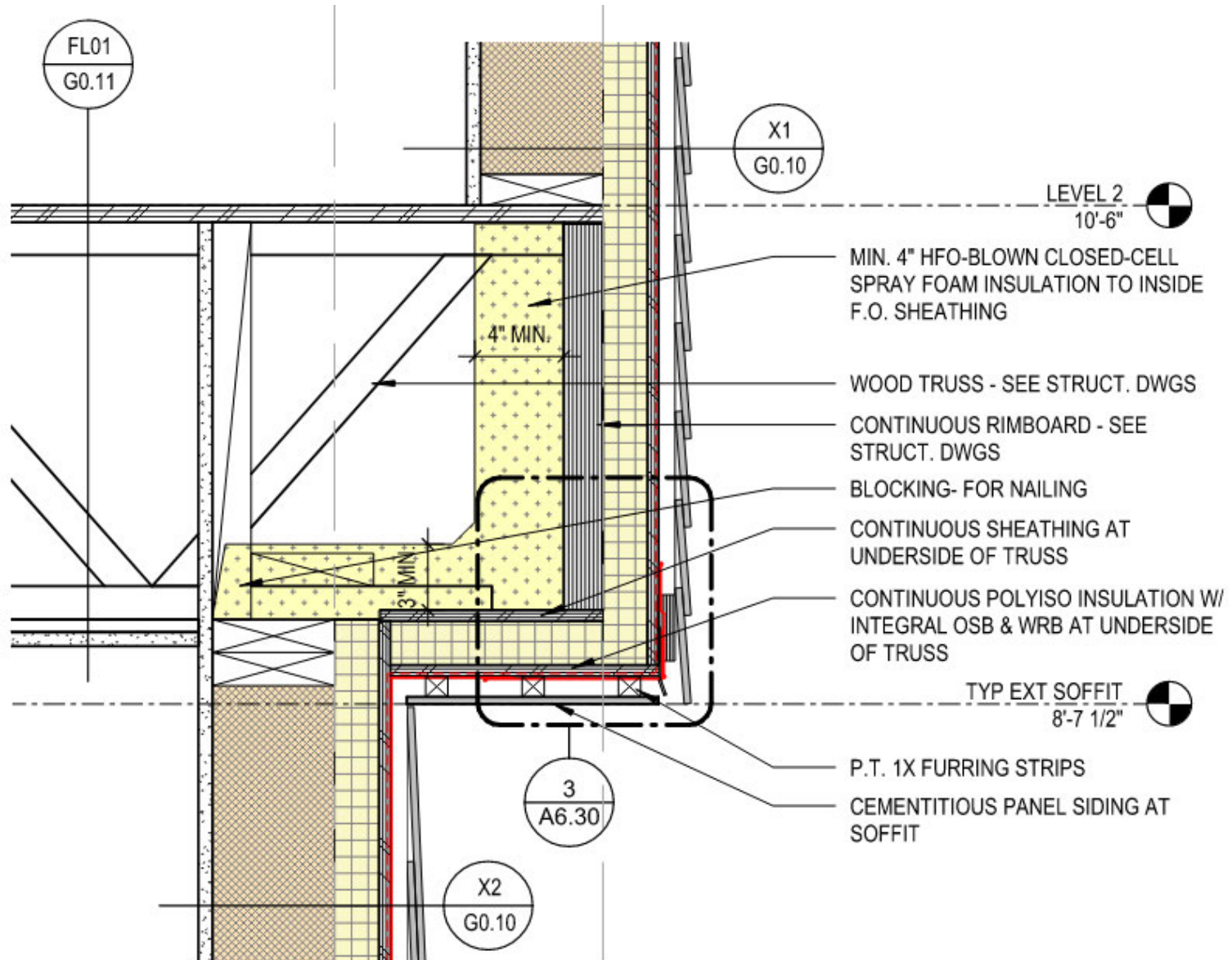

AIR SEALING: PENETRATIONS

Air Barrier – Gaskets – Sealants

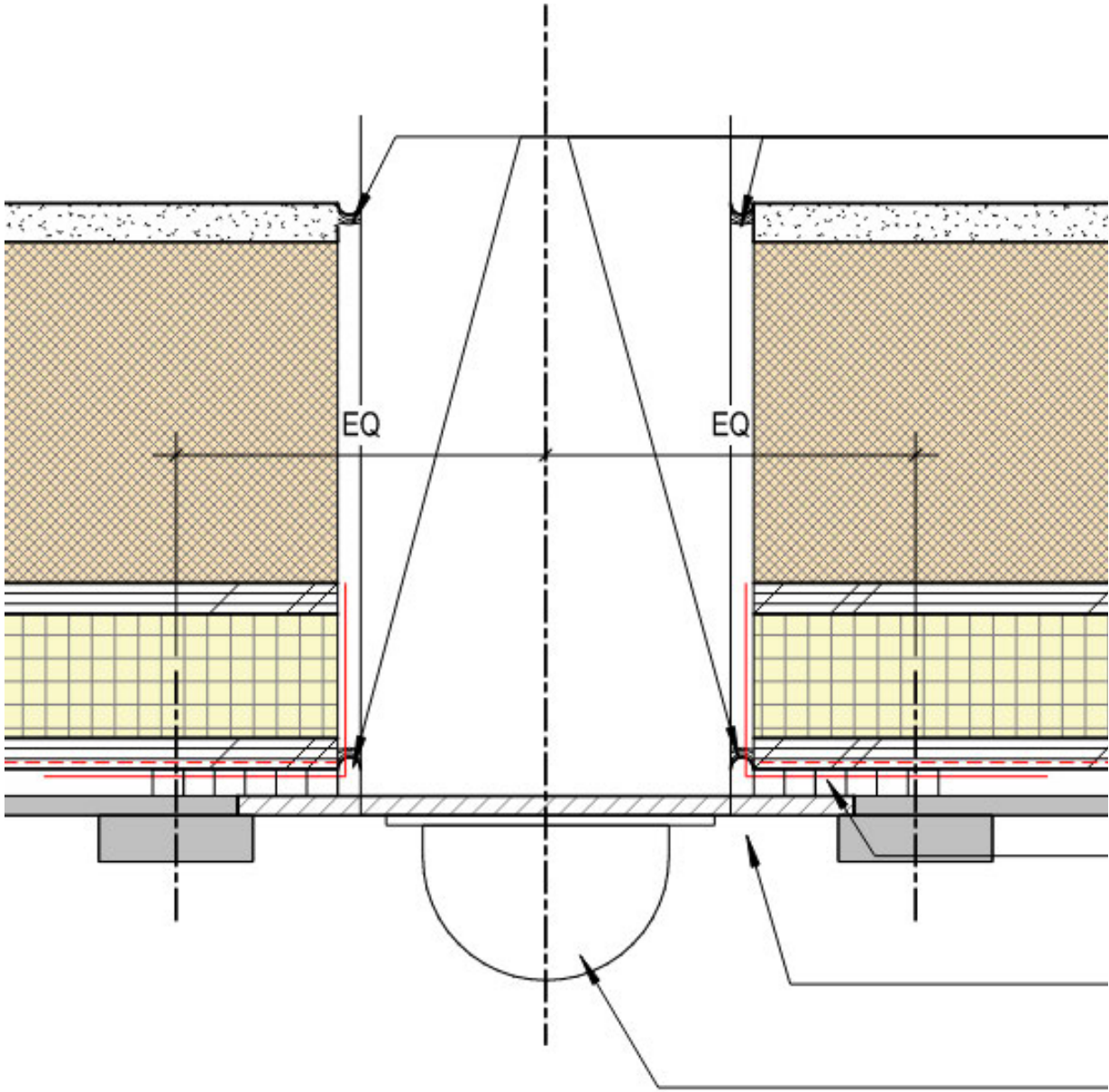
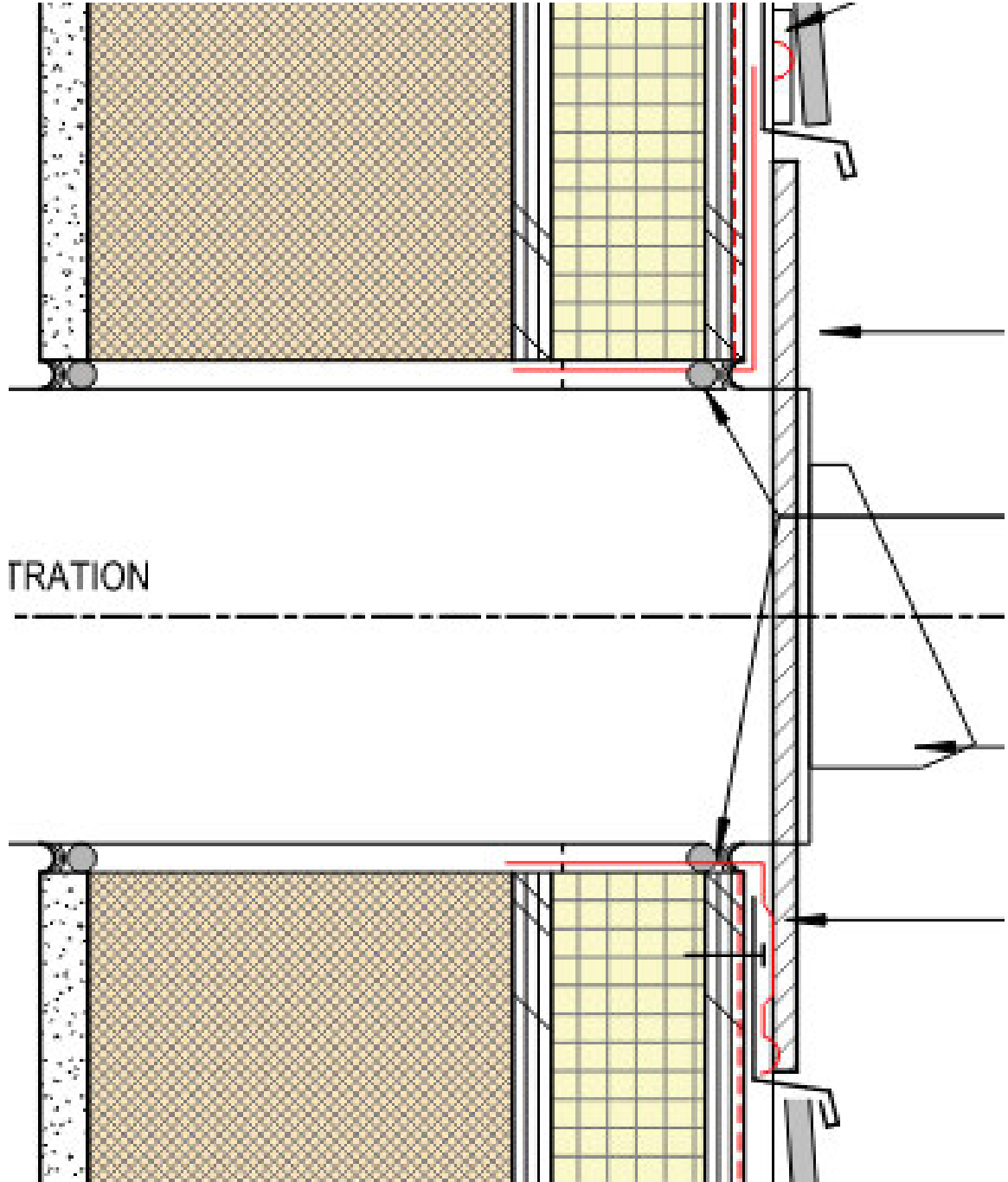
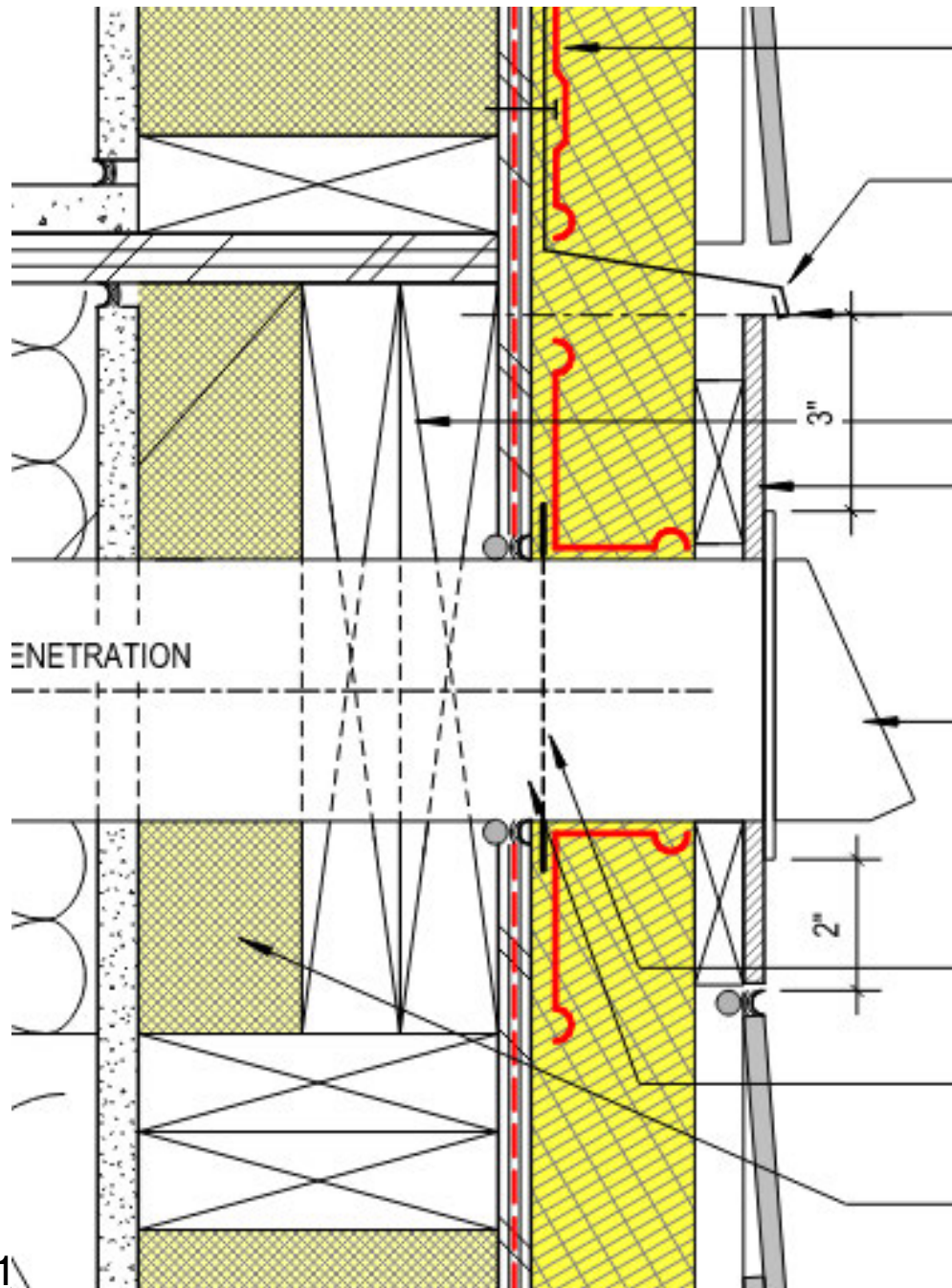

AIR SEALING: PENETRATIONS

Seal at exterior and interior; Mastic is acceptable



AIR SEALING: PENETRATIONS

Gaskets are better; Control penetrations with sleeves; Separate and seal

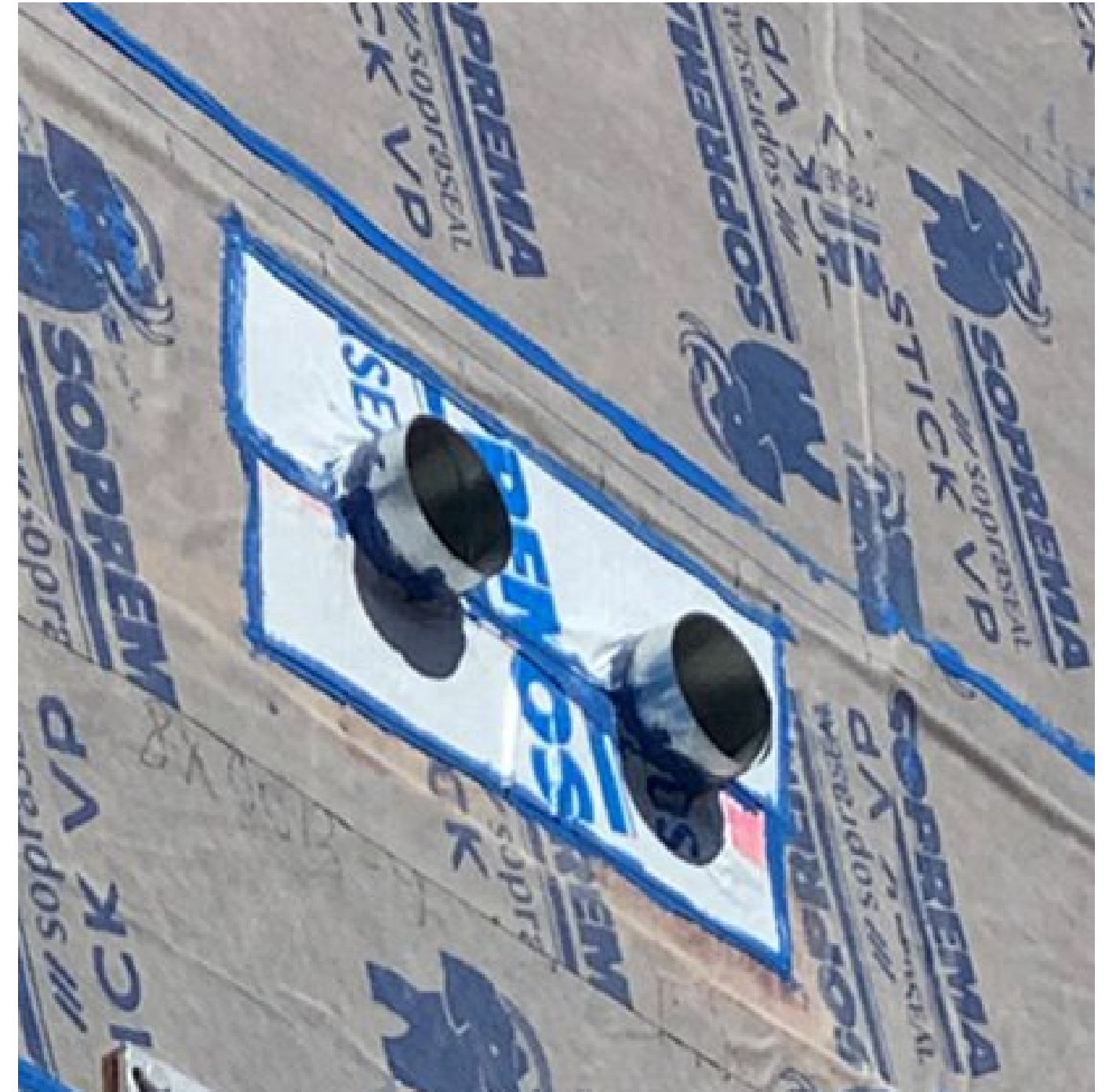
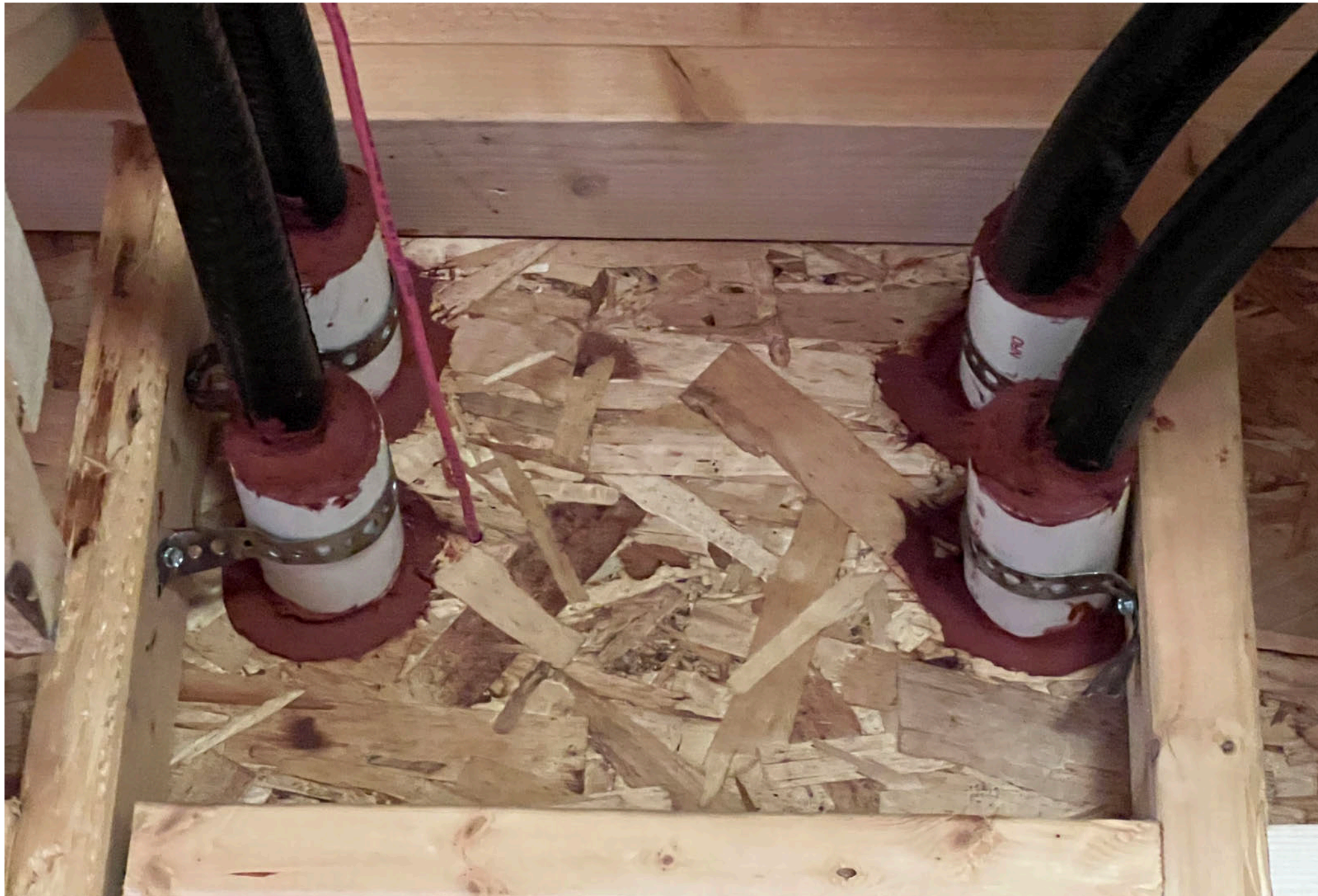

AIR SEALING: PENETRATIONS

The GOOD; The BAD; Same project



AIR SEALING: PENETRATIONS

Flood vents

- Use interior seal kit
- Considered non-threatening leakage

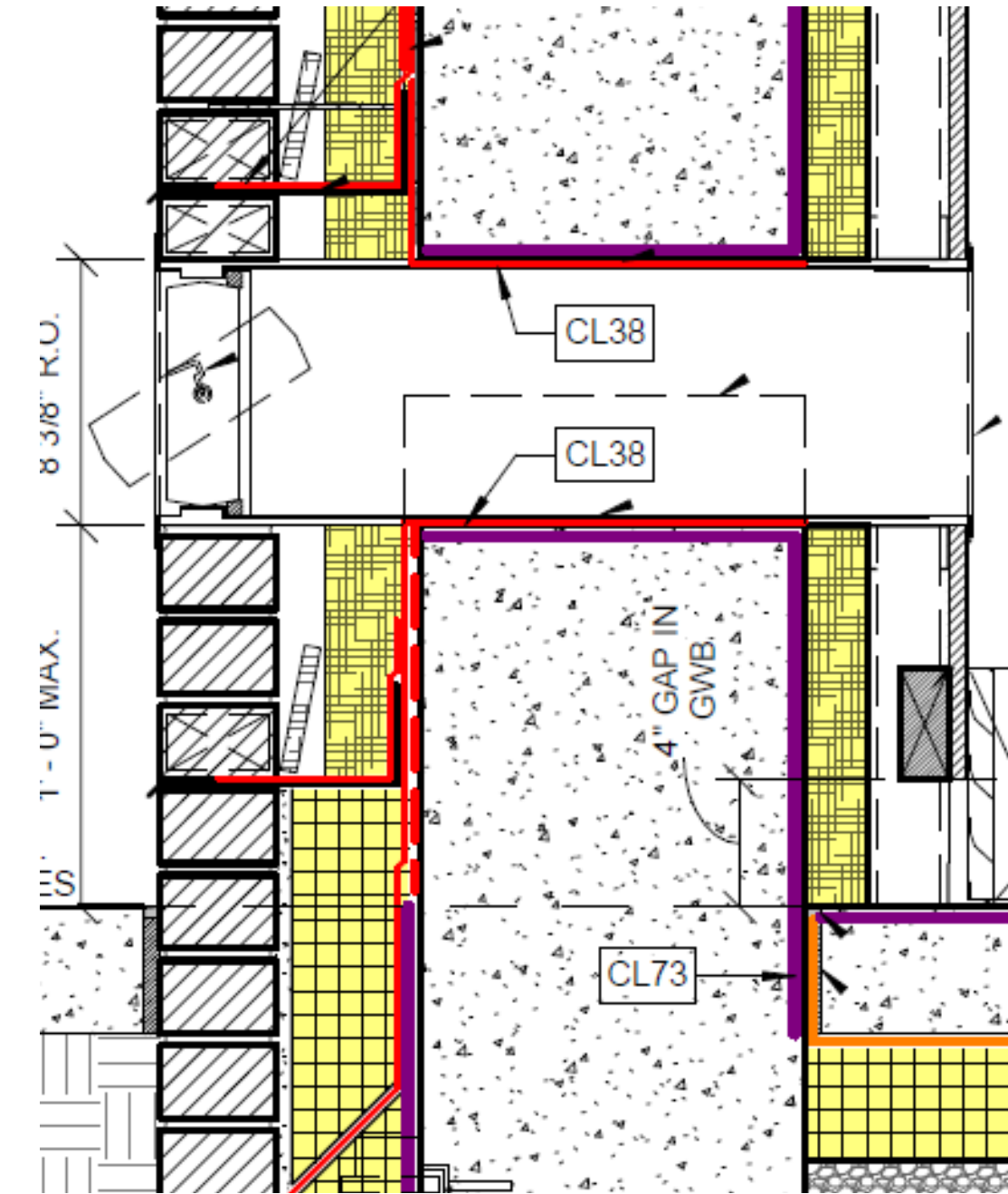
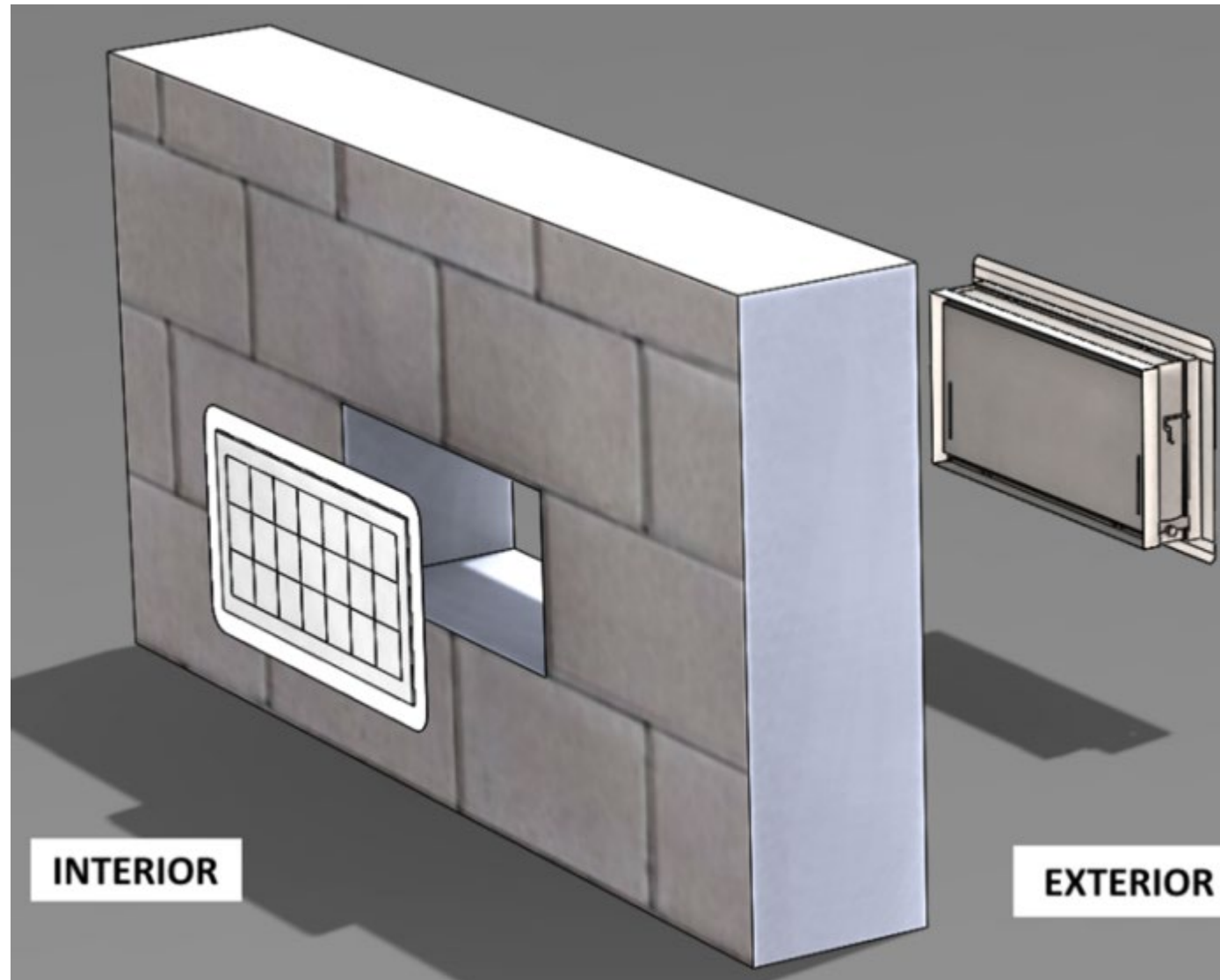

AIR SEALING: COMPARTMENTALIZATION

- Compartmentalization is a 6-sided box
- Think both in plan and section

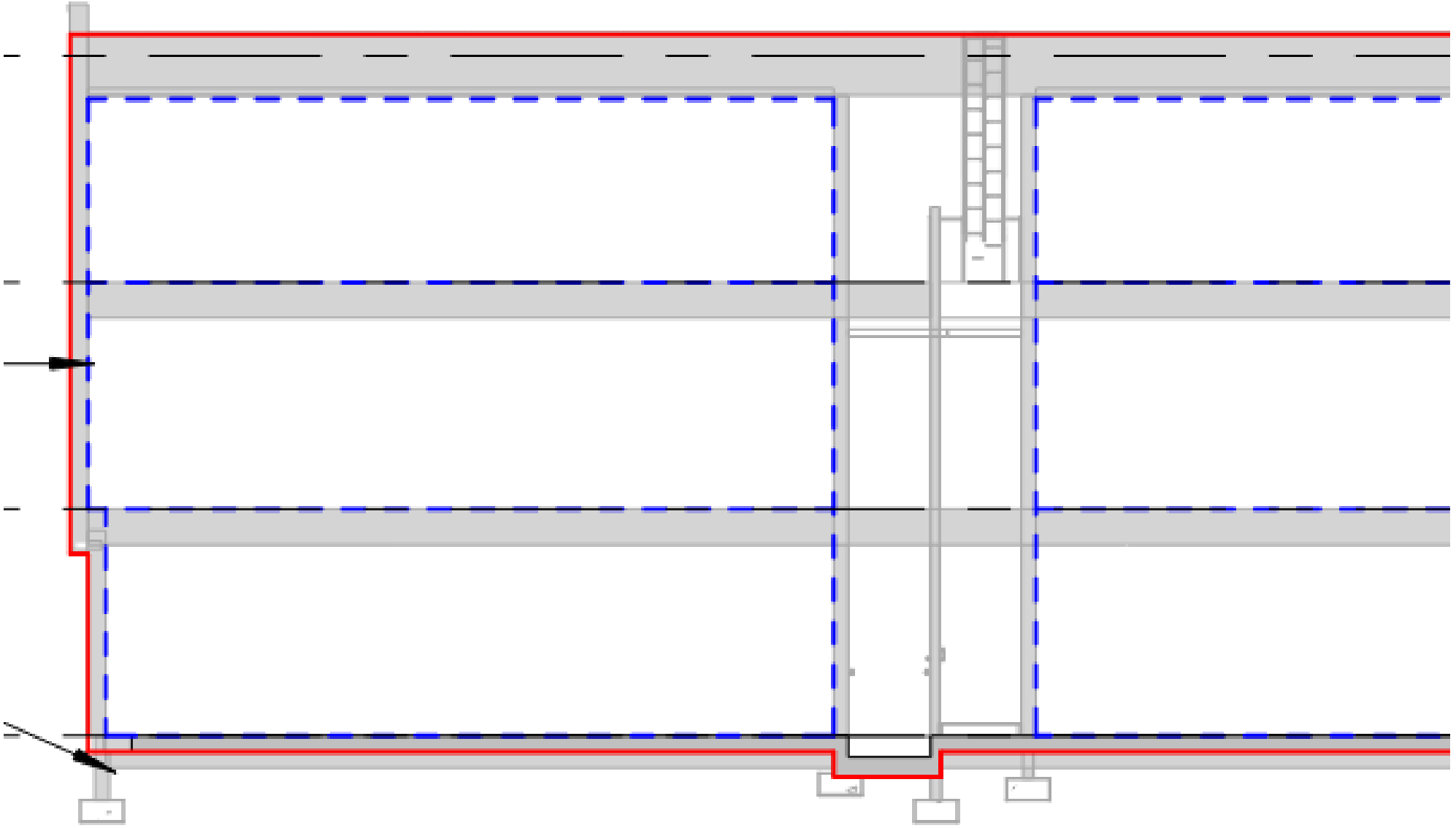
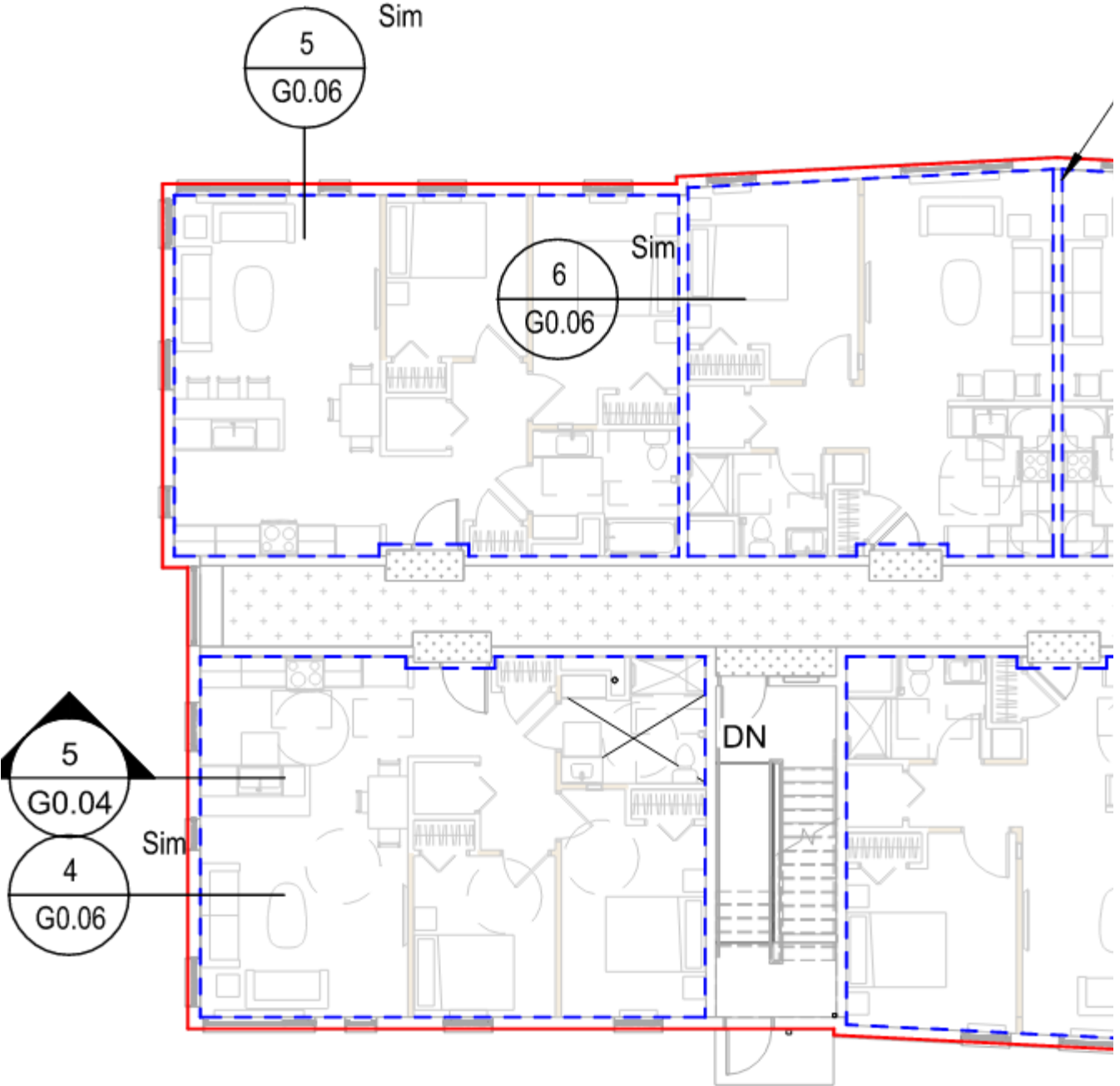

AIR SEALING: COMPARTMENTALIZATION

Putty packs are best; Always seal box to GWB

Alternate stud bays for boxes in adjacent units in a shared demising wall

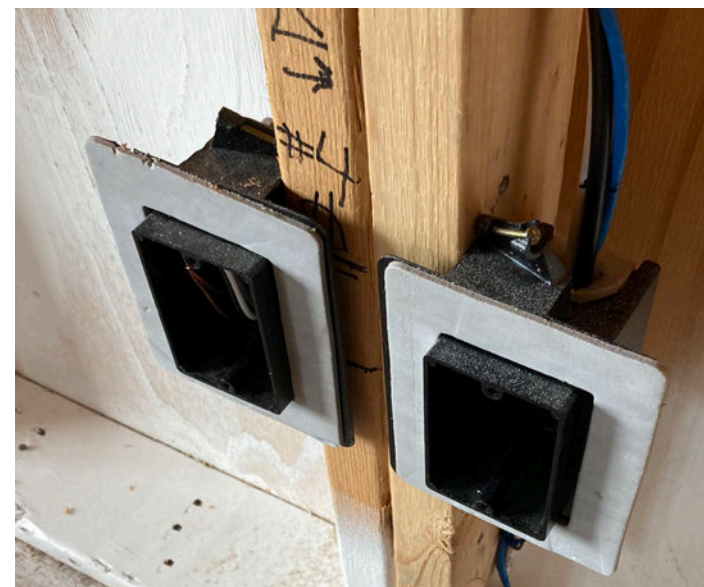

AIR SEALING: COMPARTMENTALIZATION

Compartmentalization much more difficult below podium



AIR SEALING: COMPARTMENTALIZATION

Seal at all truss penetrations: chords, webs
Look 'above' penetrations



AIR SEALING: COMPARTMENTALIZATION

Joint compound is not sufficient
Separate penetrations to seal



AIR SEALING: WALLS

- GWB & sheathing create compartmentalization boundary
- Top-chord bearing trusses reduces the extent of "castle cutting" and sealing at complex geometries

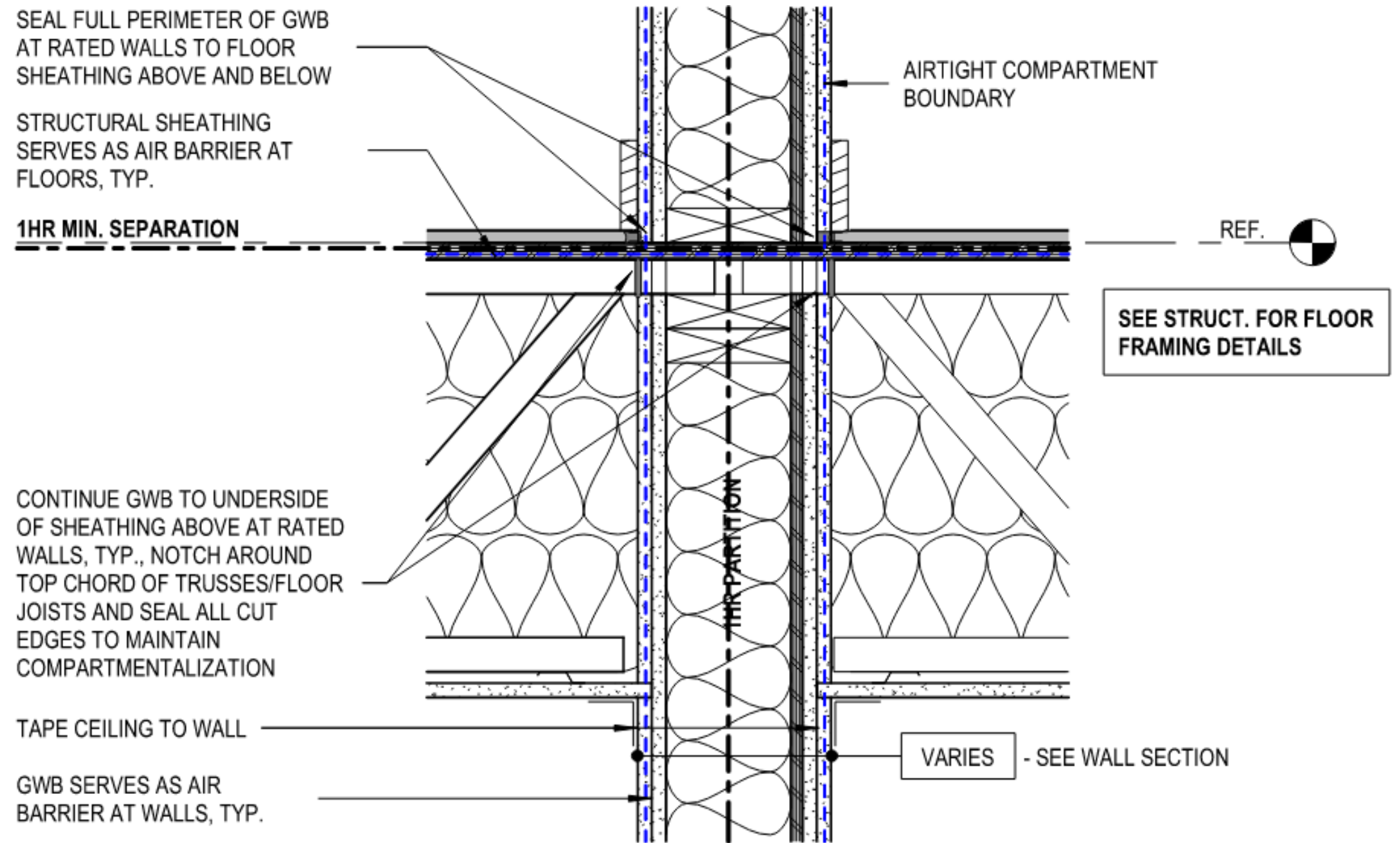

- 4

SECTION - TYP. AIR SEALING AT FRAMING PERPENDICULAR TO WALL

1 1/2" = 1'-0"

AIR SEALING: COMPARTMENTALIZATION

- Top-chord bearing wood trusses
- GWB continuous over entry alcove

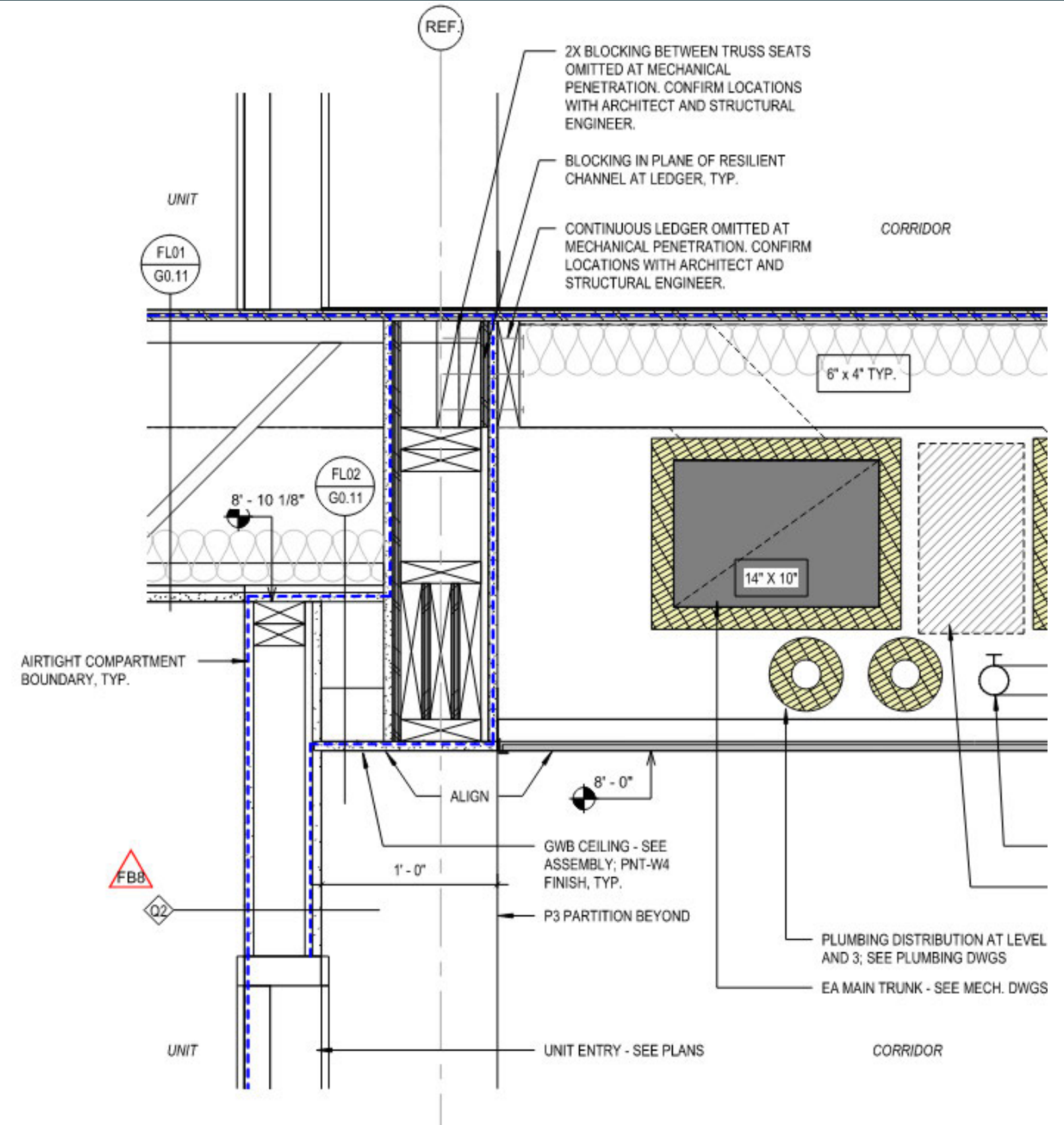

AIR SEALING: WALLS

- GWB & sheathing create compartmentalization boundary
- Offset structural truss hanger
- GWB continuous to the underside of sheathing
- Seal exterior sheathing to wall top/bottom plates
- CCSPF for gaps in wood framing

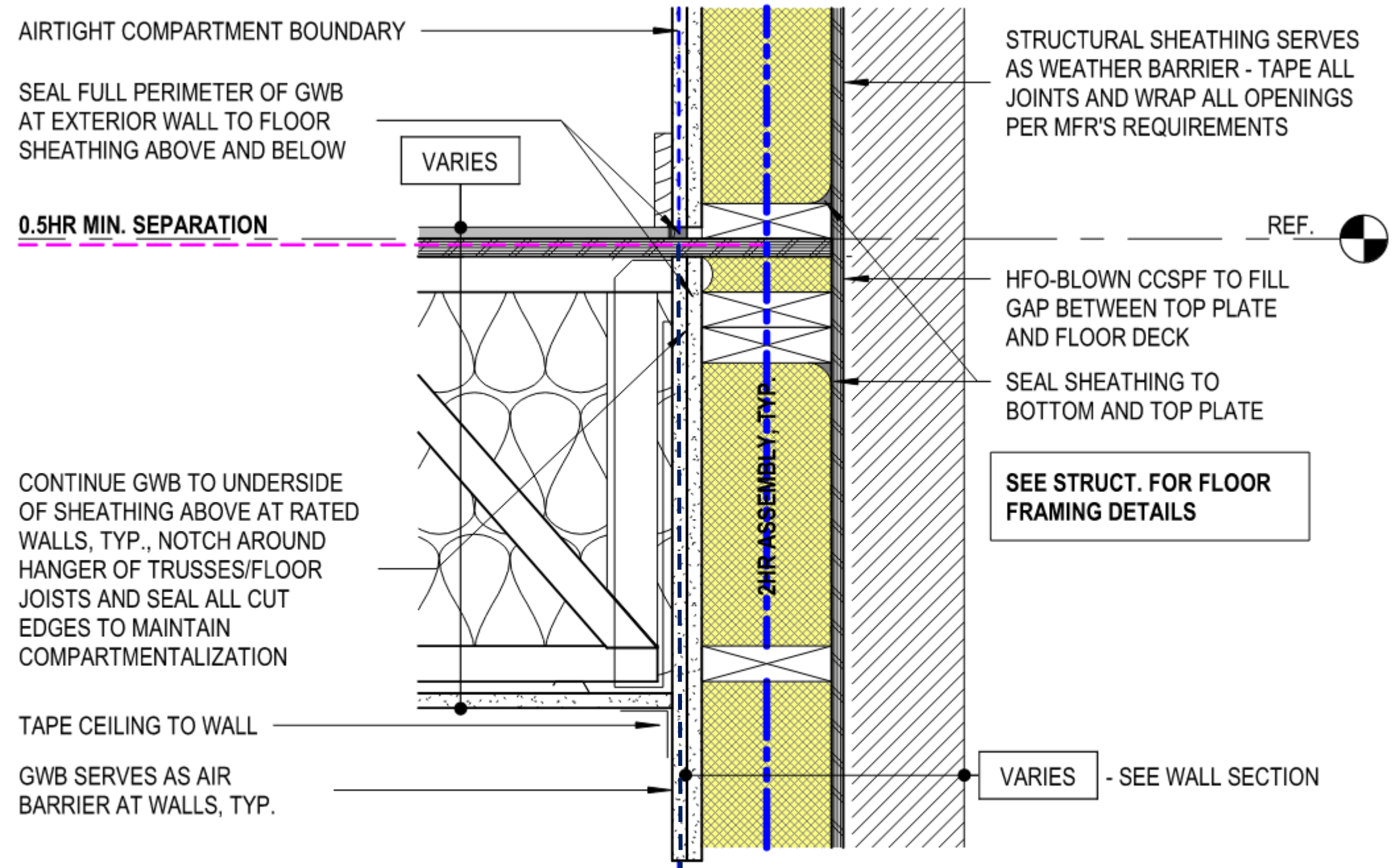

11 SECTION - TYP. AIR SEALING AT EXTERIOR BEARING WALL
1 1/2" = 1'-0"

AIR SEALING: COMPARTMENTALIZATION

Spray sealant is your friend

Seal at floor and deck

Seal at corners

Seal at demising walls



AIR SEALING: COMPARTMENTALIZATION

Medicine cabinets must be sealed

Media panels, electrical panels should never be located on demising walls



AIR SEALING: WINDOWS

Sealants work

Interior and exterior must be sealed to flashed RO

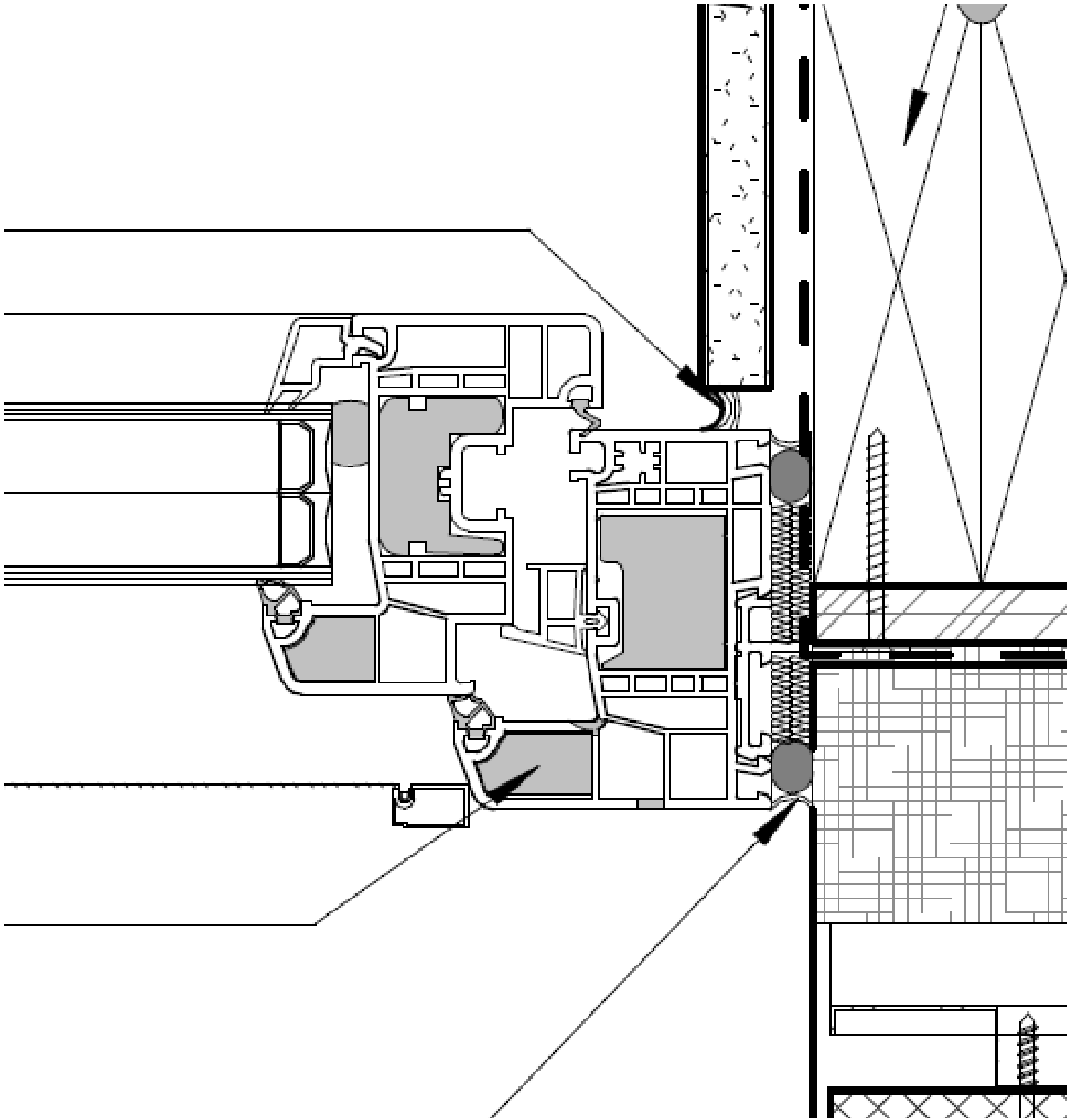
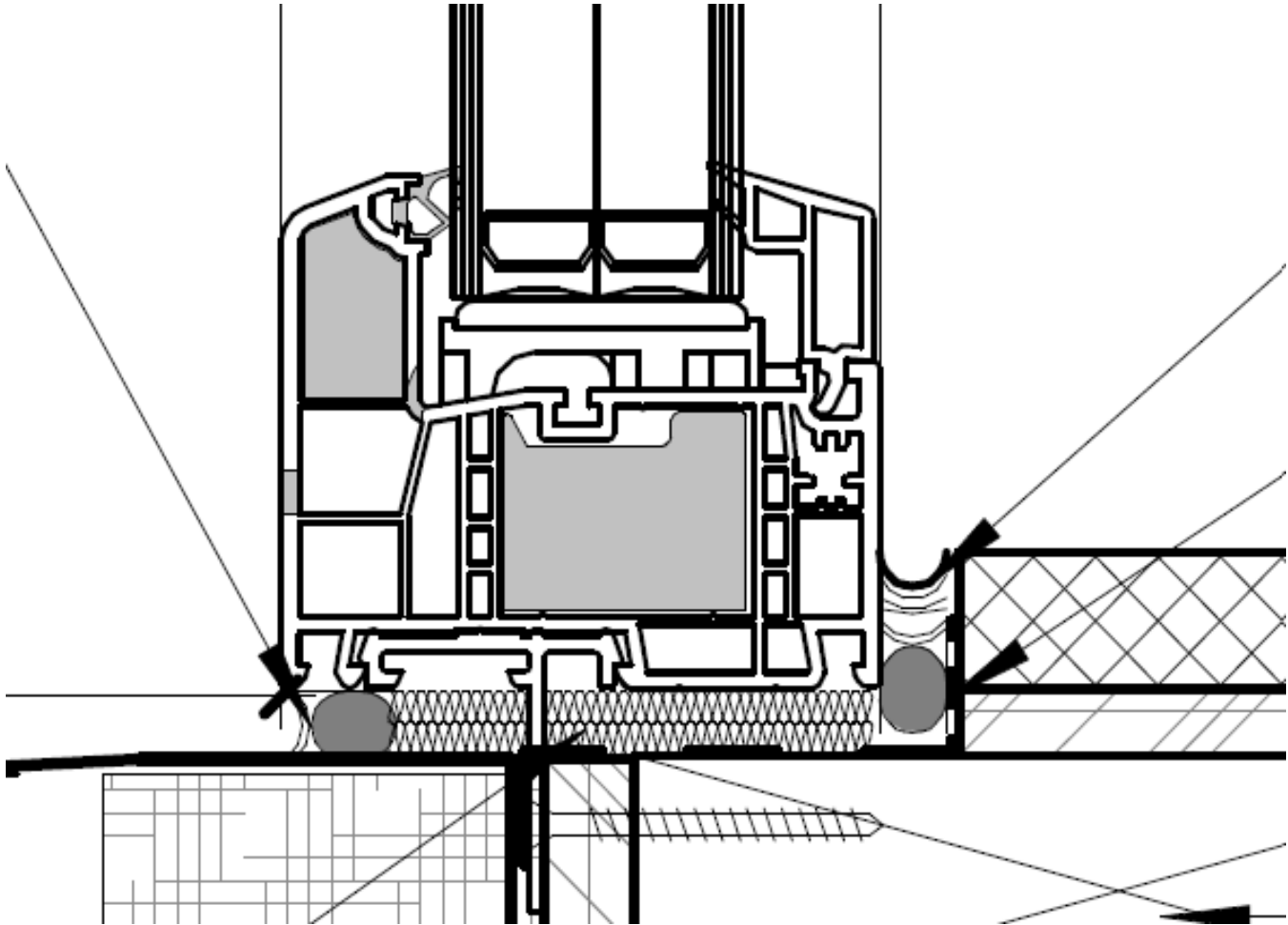

AIR SEALING: WINDOWS

Clip windows are great, but clips must be sealed



AIR SEALING: WINDOWS

Caulk sealing window with installation clips



Interior Seal top and bottom at clip



Interior Seal at Clip – Set in sealant



Exterior Seal

AIR SEALING: WINDOWS



TAPE IS BEST

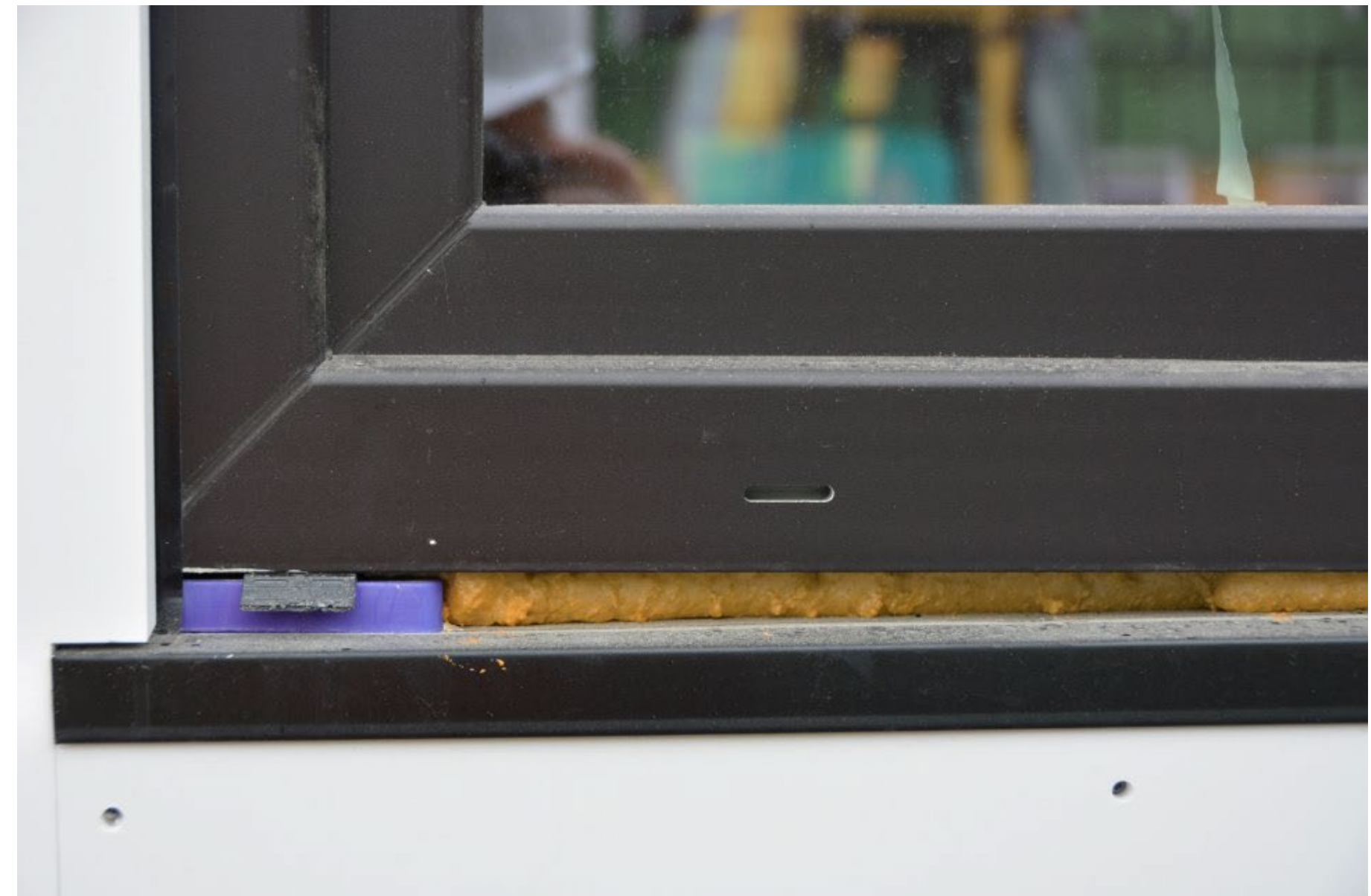

FOAM IS NOT ENOUGH

AIR SEALING: WINDOWS



AIR SEALING: WINDOWS

Just a reminder: your best efforts are only as good as the installation.

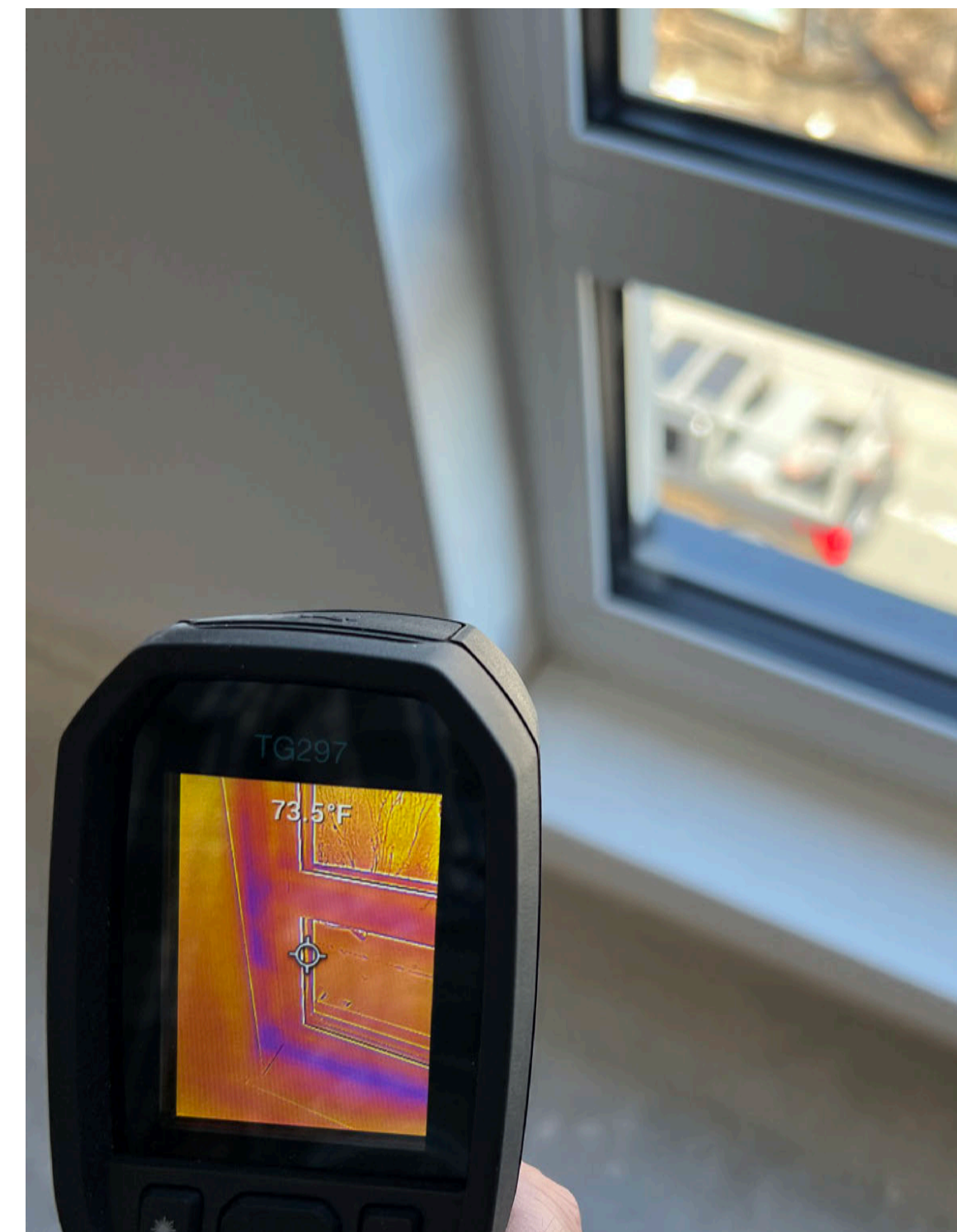

AIR SEALING: WINDOWS



AIR SEALING: ROOF

Roof AV barrier must be connected to WRB



AIR SEALING: ROOF PENETRATIONS

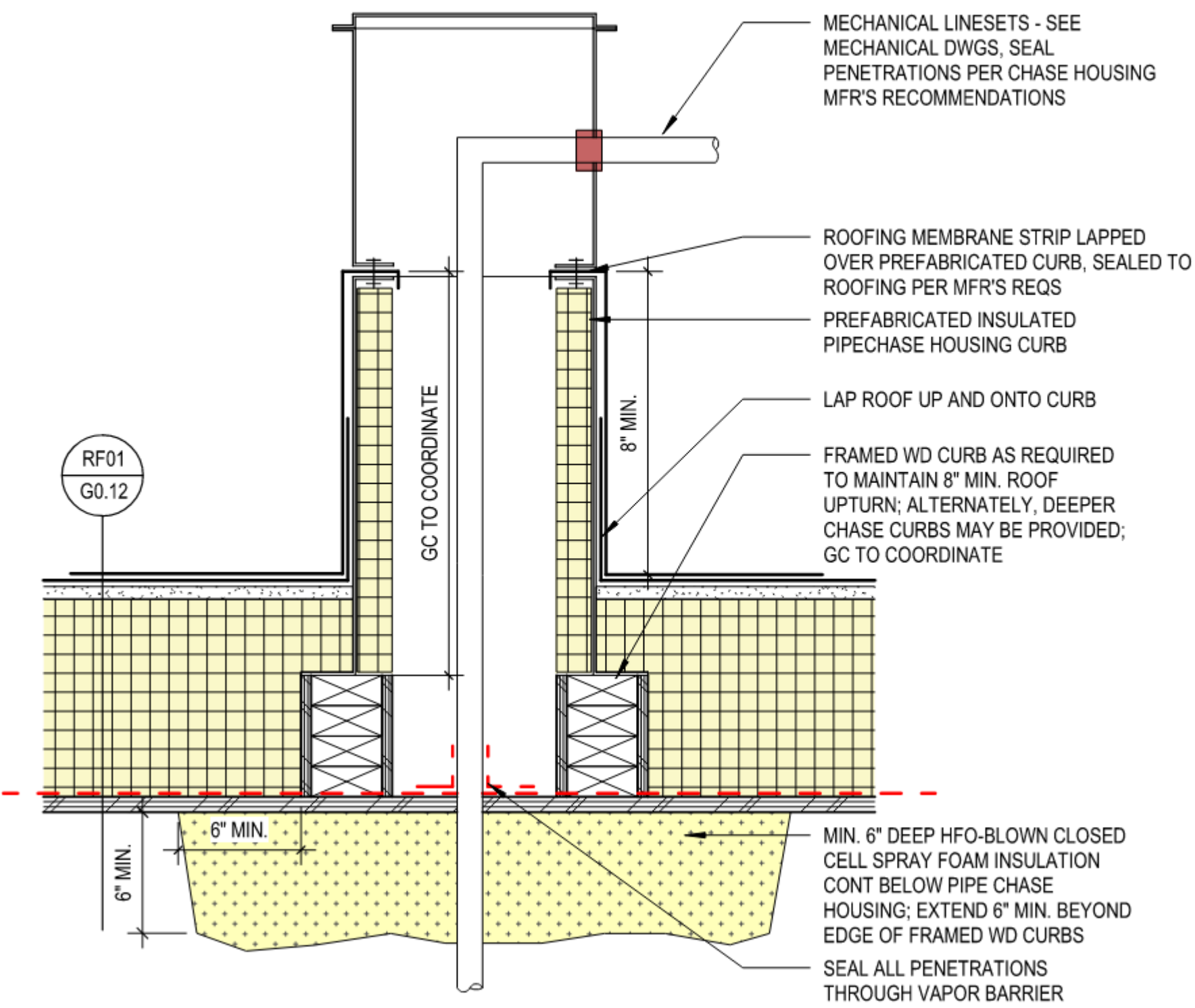
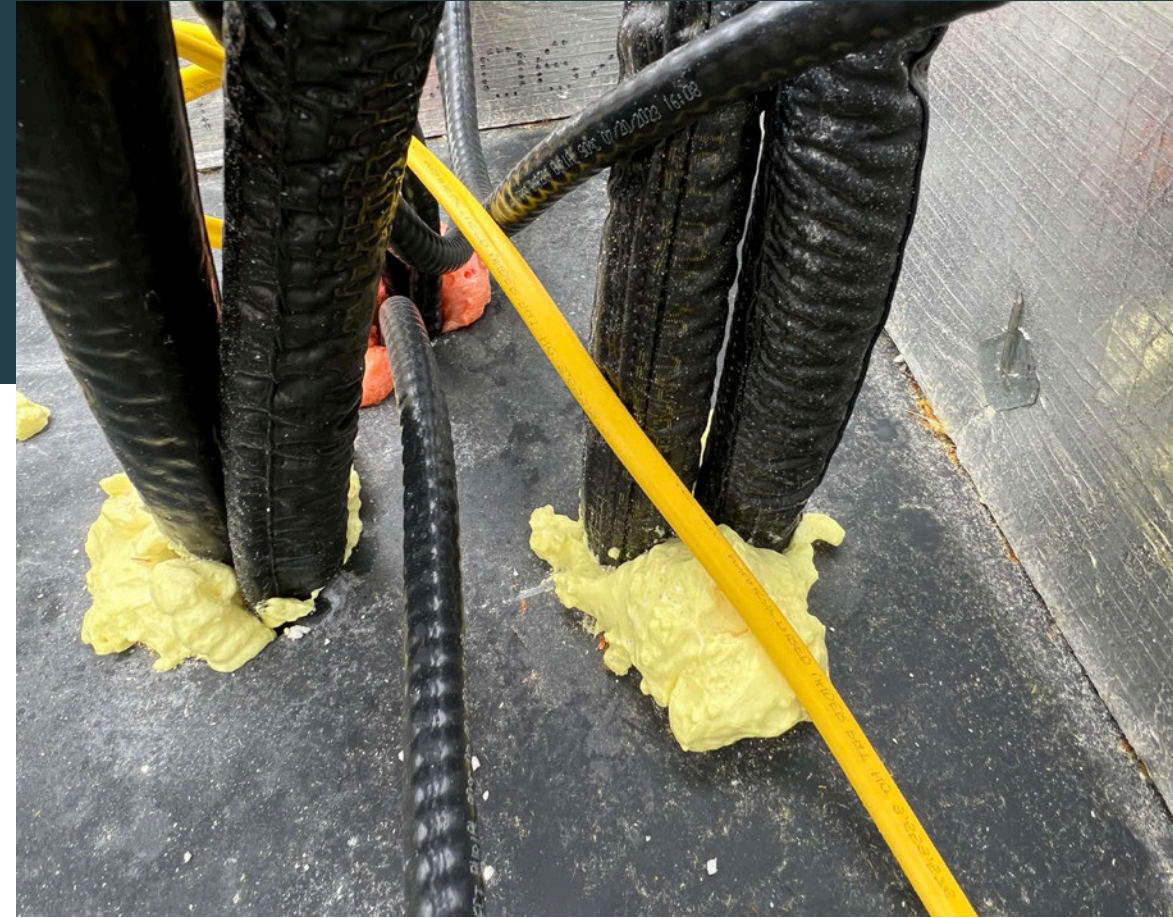

AIR SEALING: PARAPET

Parapets are tricky:

- NFPA 285
- Multiple trades
- Phius "focus"

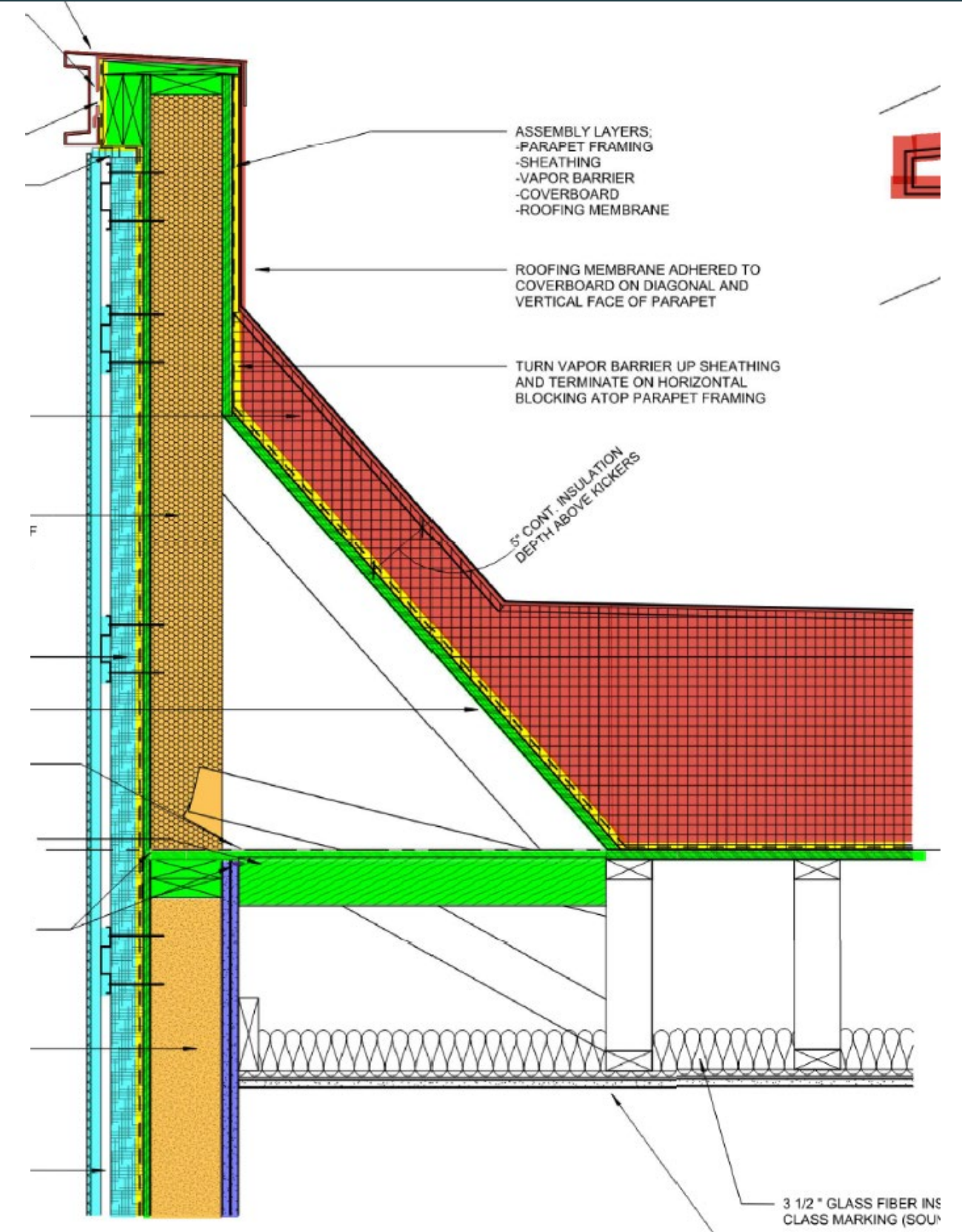
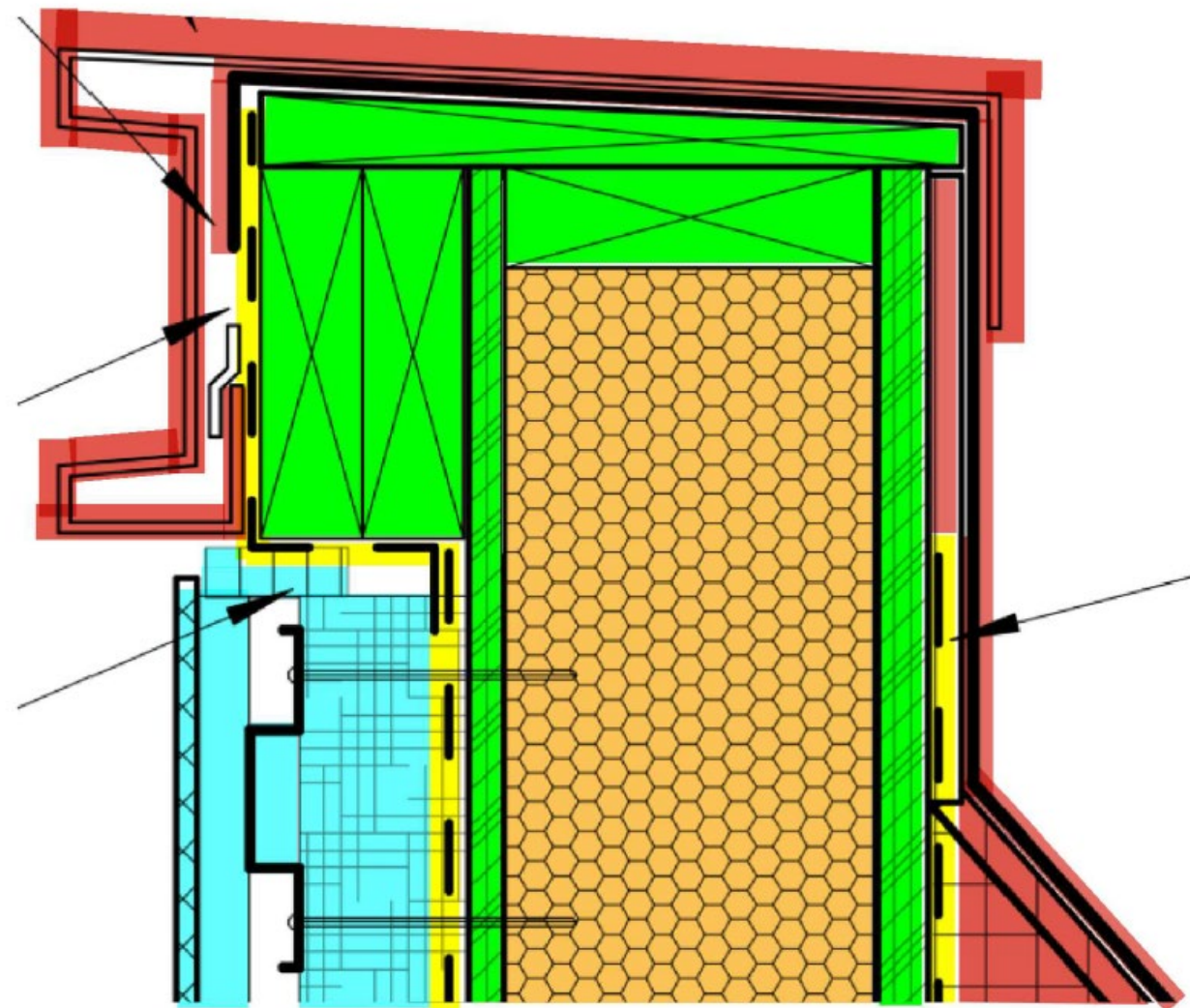

AIR SEALING: PARAPET

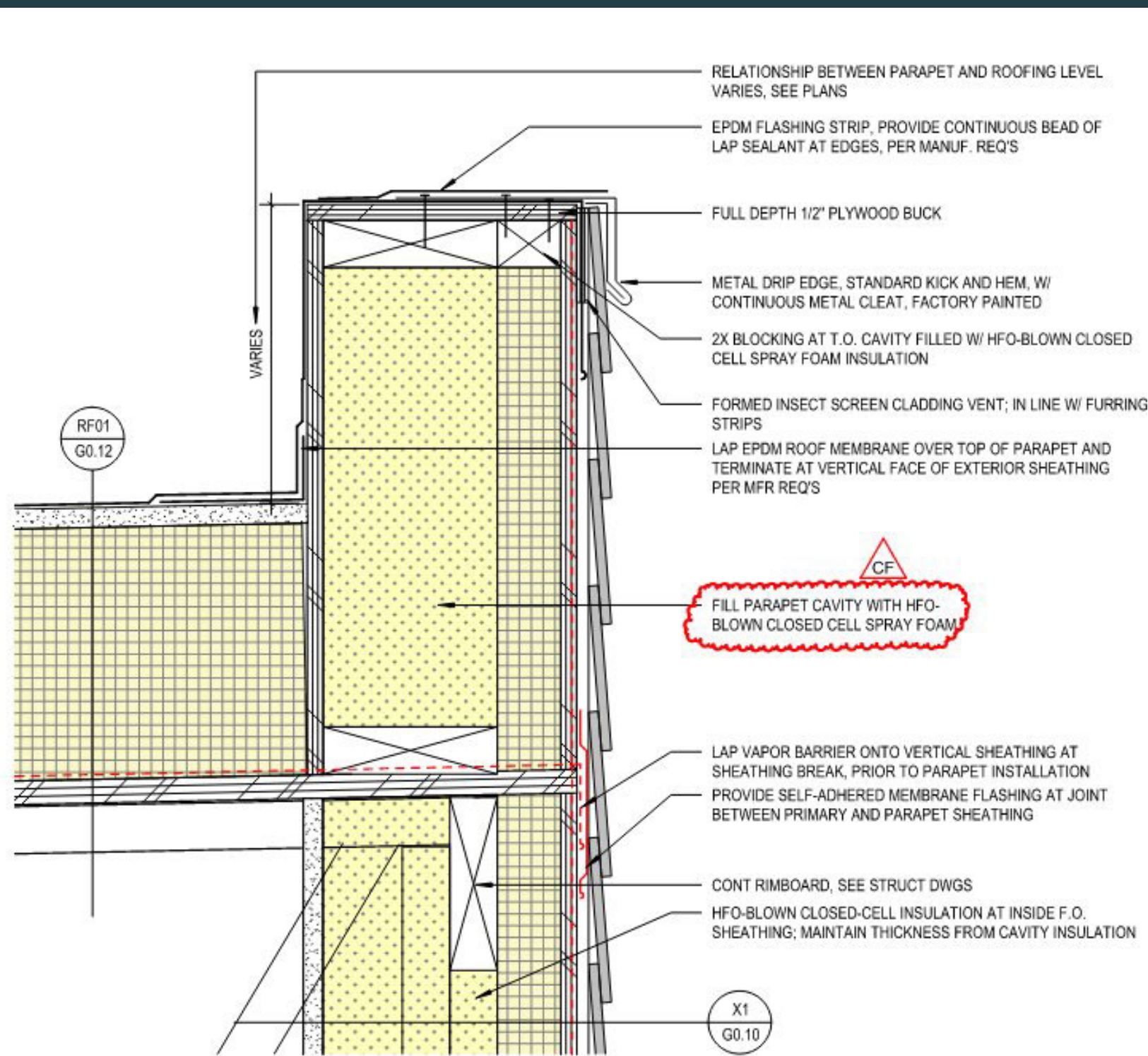

5 SECTION DETAIL - TYPICAL PARAPET
3" = 1'-0"

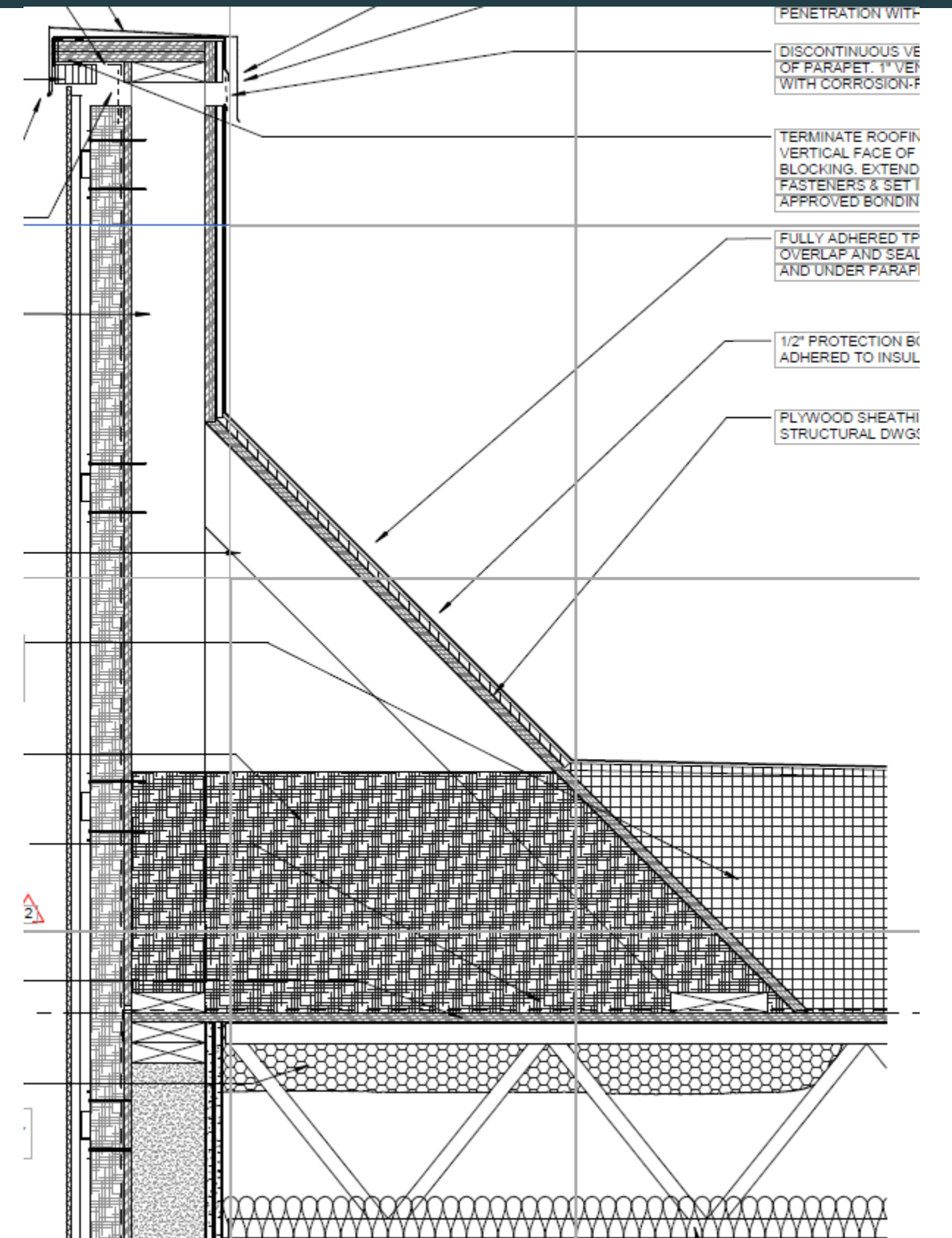

AIR SEALING: PARAPET

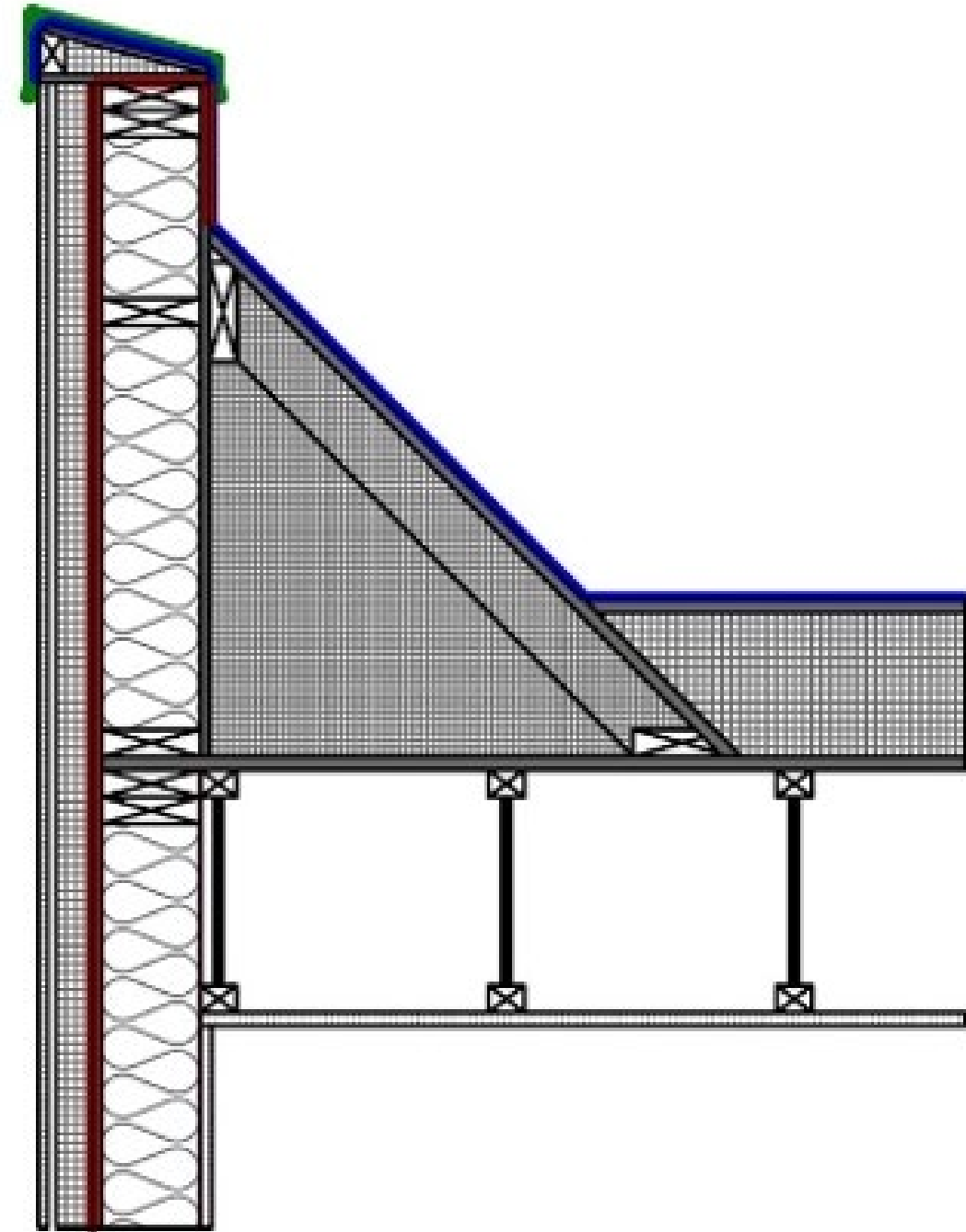
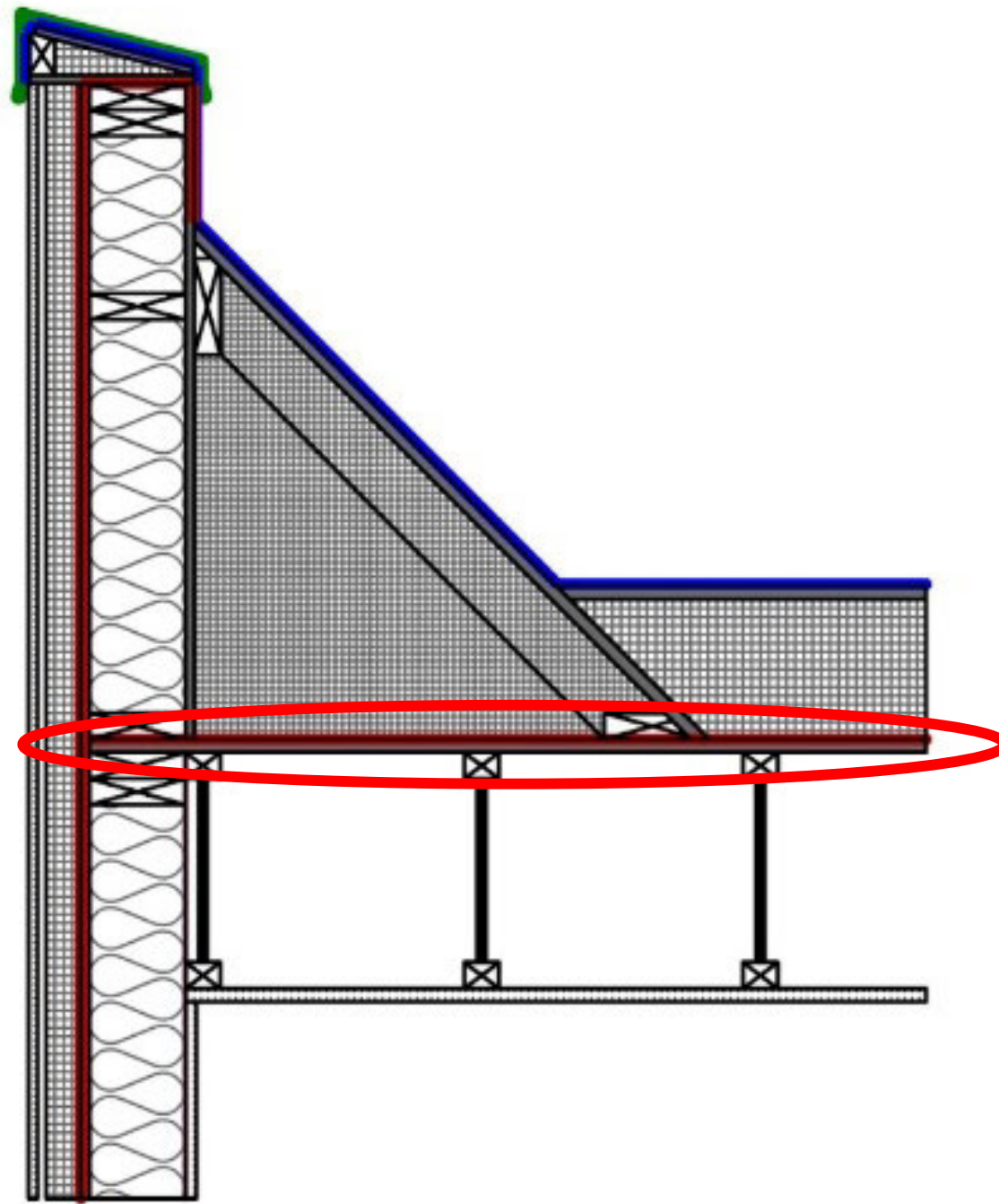

AIR SEALING: COMPACTOR ROOM AND TRASH CHUTE

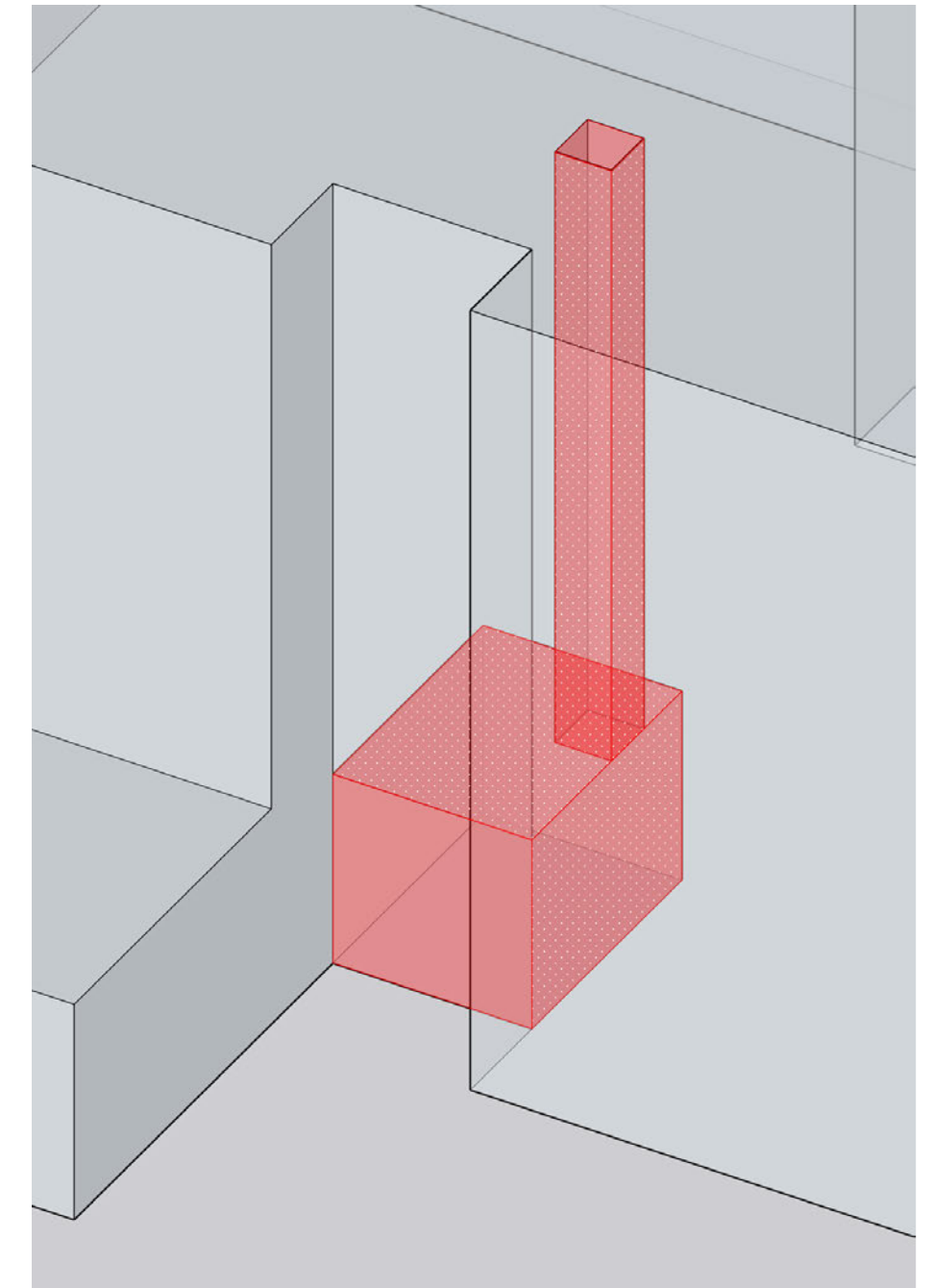
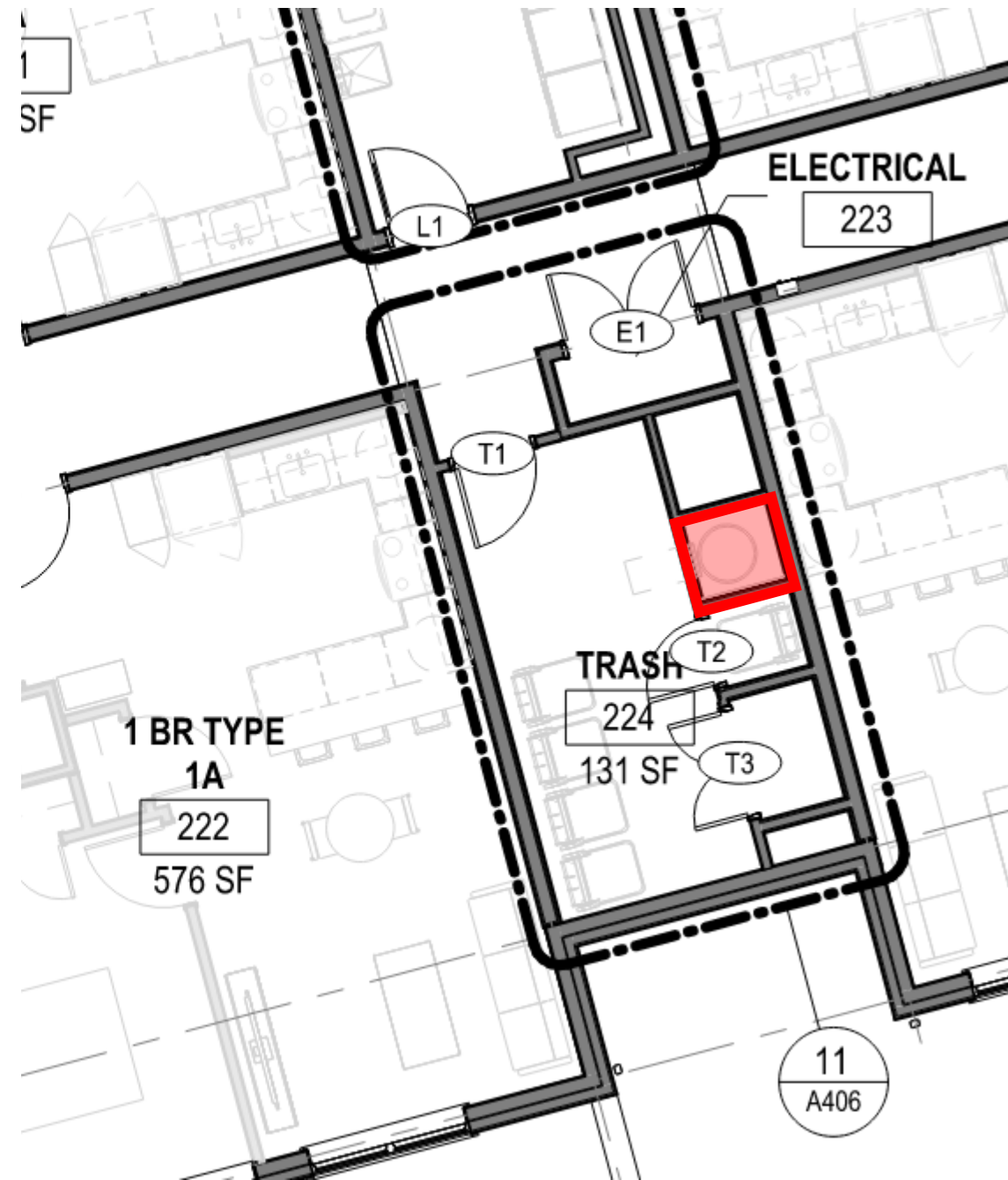
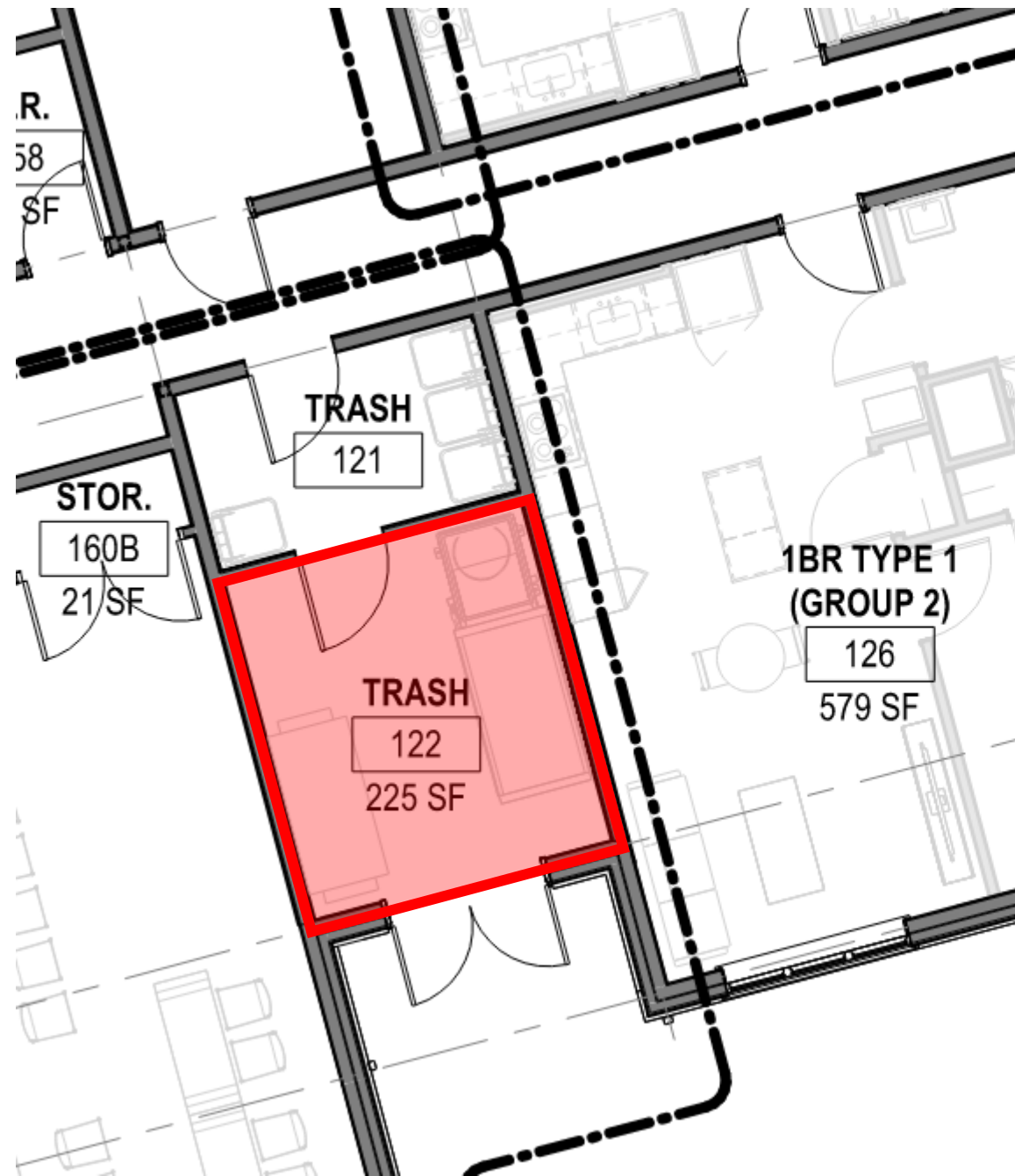

AIR SEALING: COMPACTOR ROOM AND TRASH CHUTE

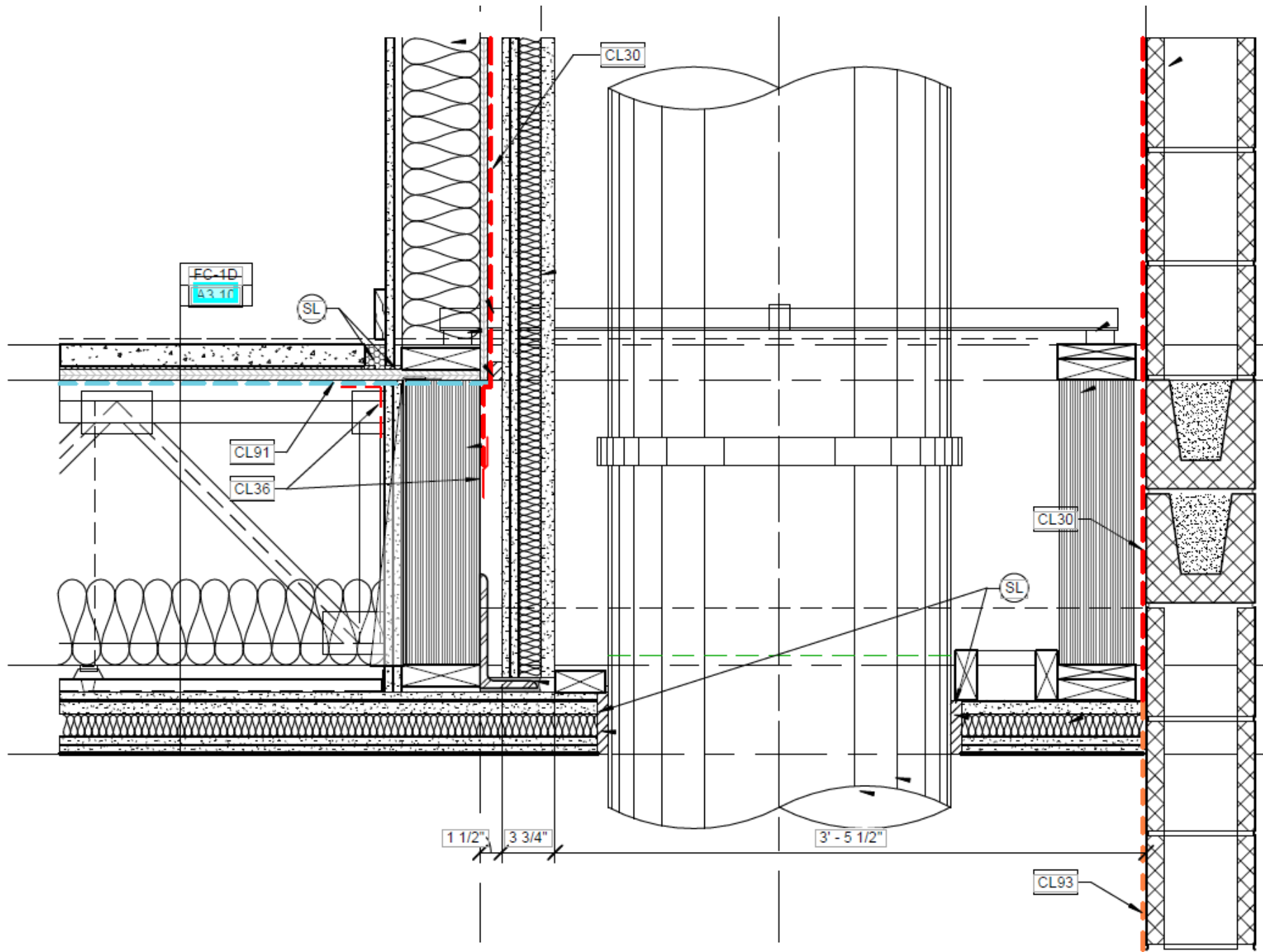
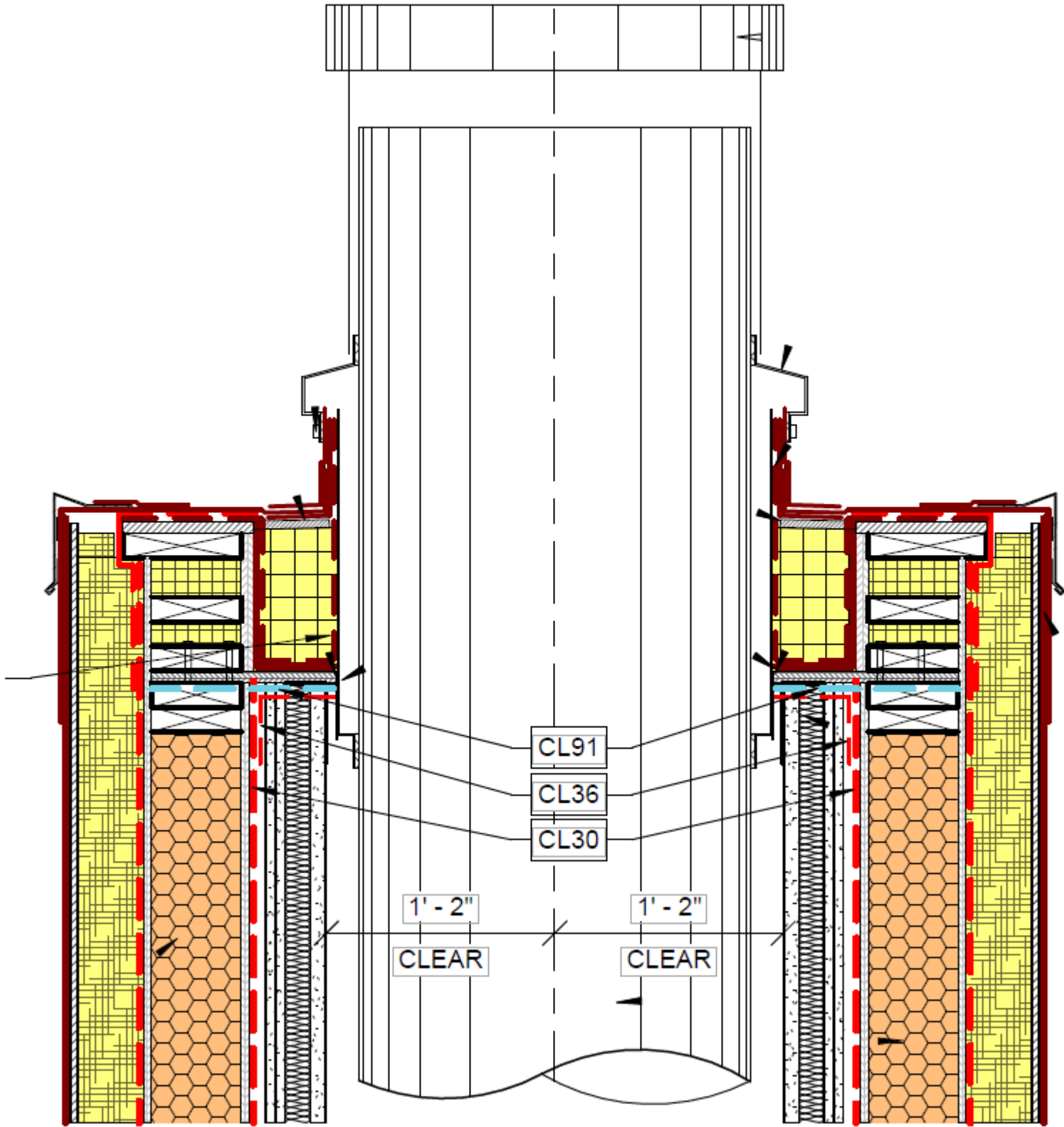

AIR SEALING: COMPACTOR ROOM AND TRASH CHUTE

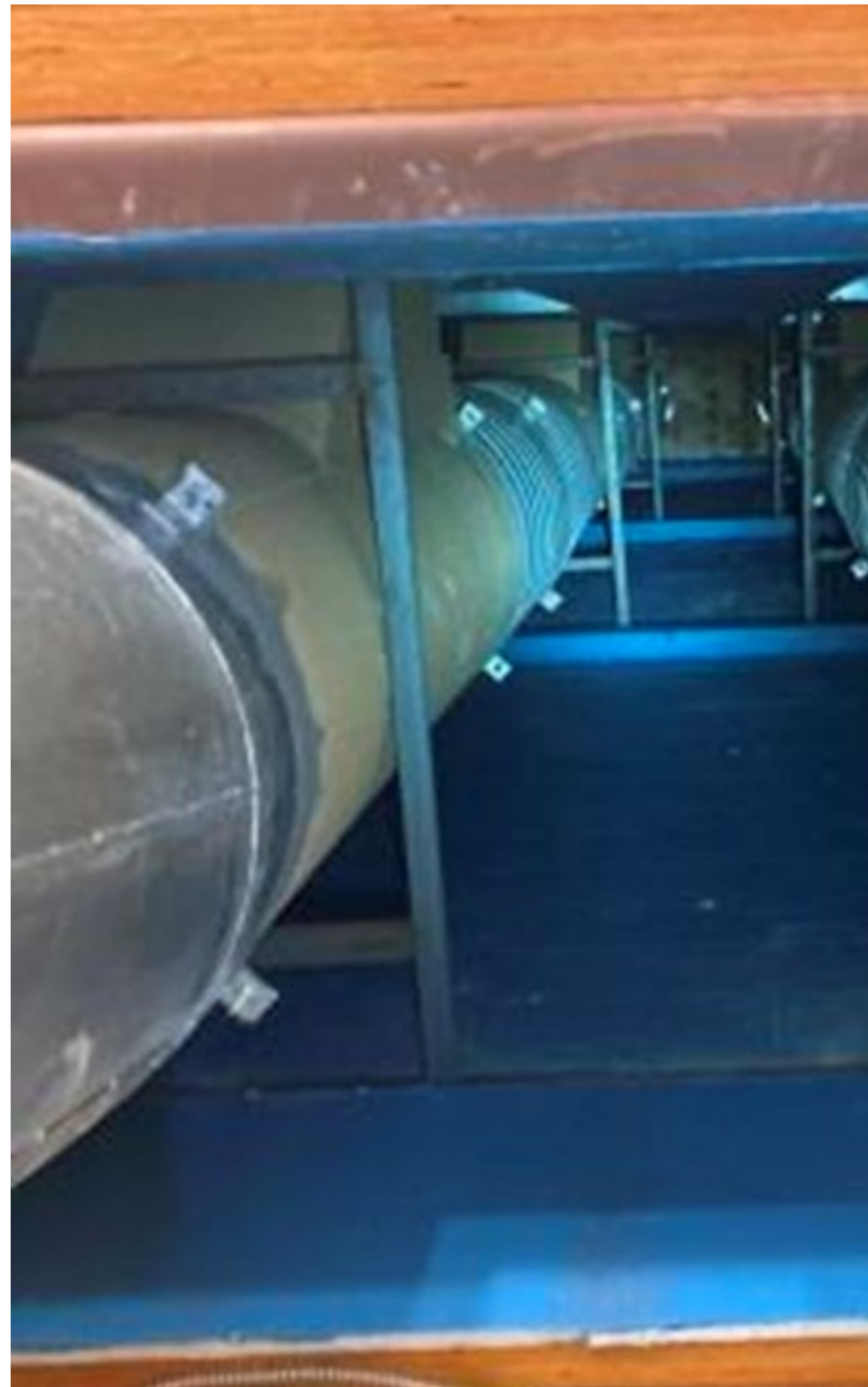

AIR SEALING: ROOF CURBS



Good air seal, but the insulation or lack thereof, needs work.

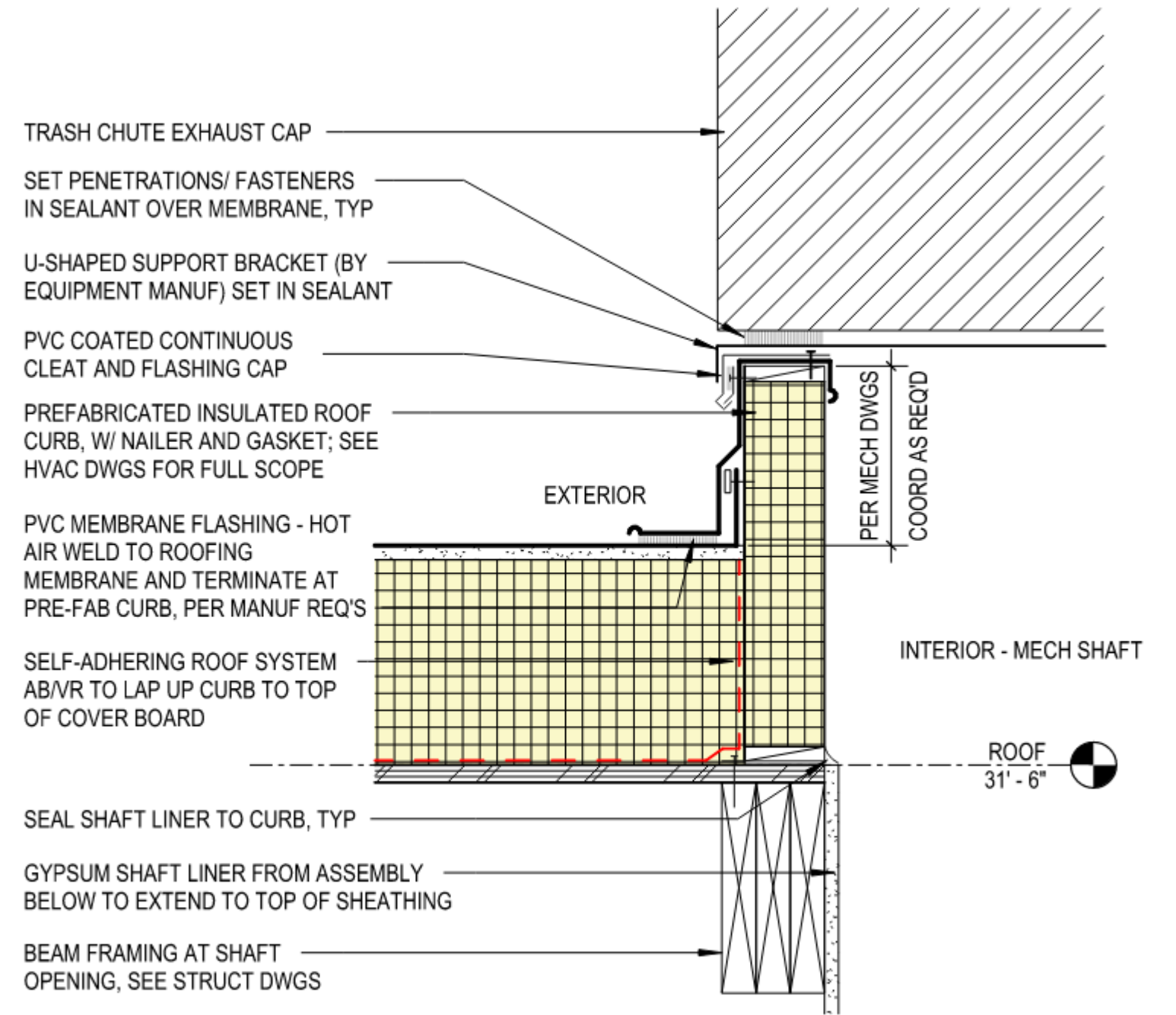

SECTION DETAIL - ROOF CURB AT EXHAUST / SHAFT PENETRATION

Laundry Rooms

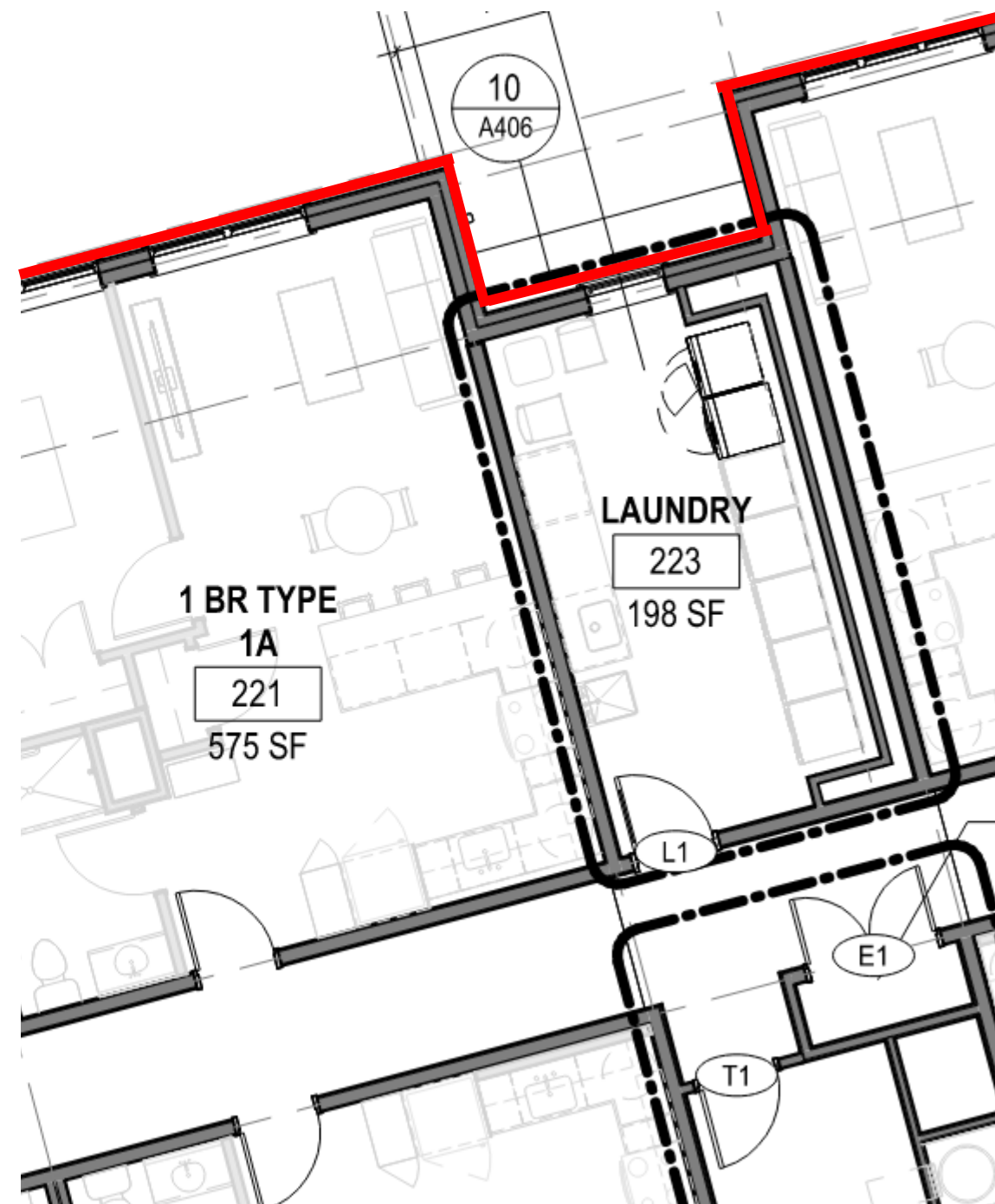
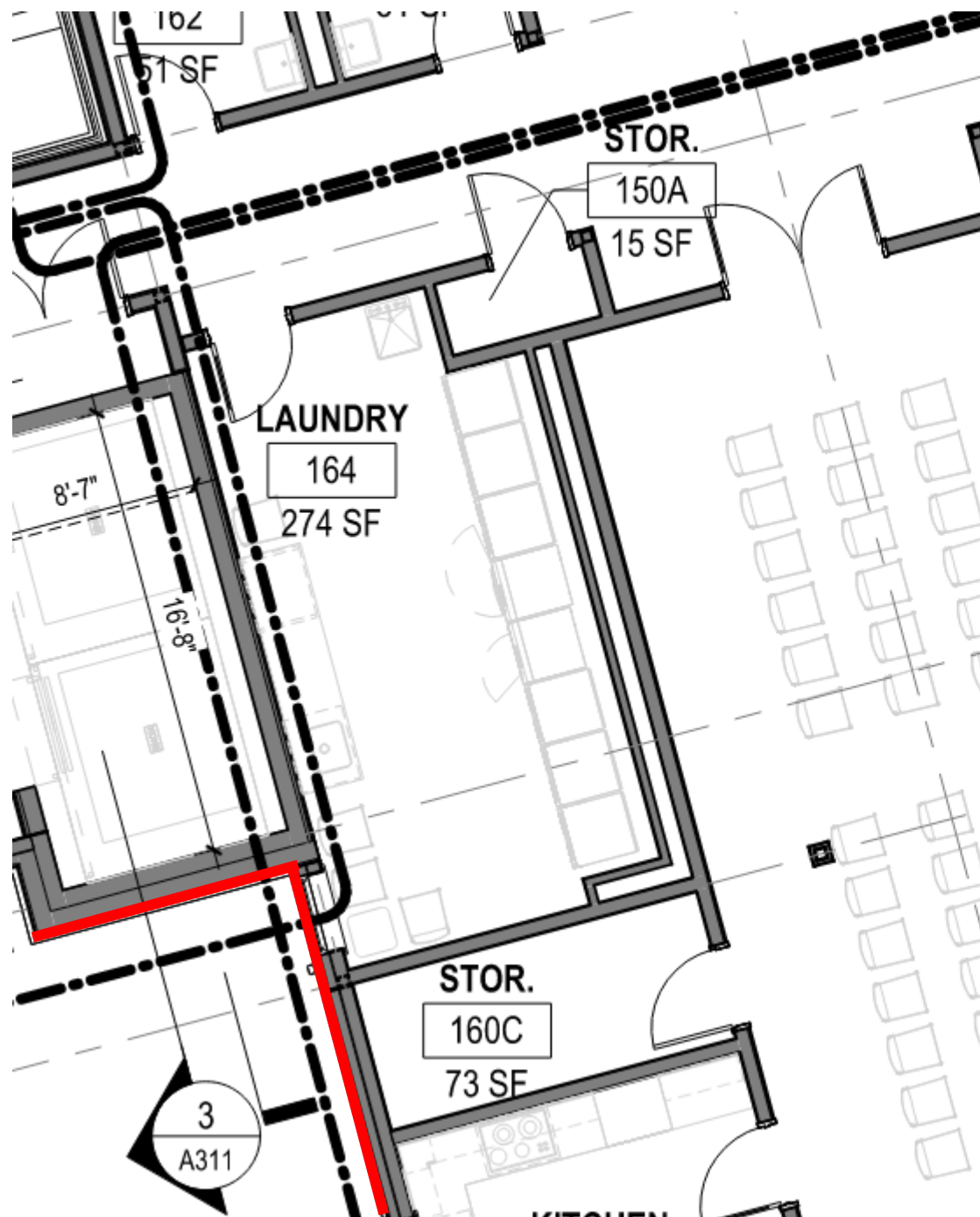

Clothes dryer exhaust considerations, but also makeup air is needed

Laundry Rooms

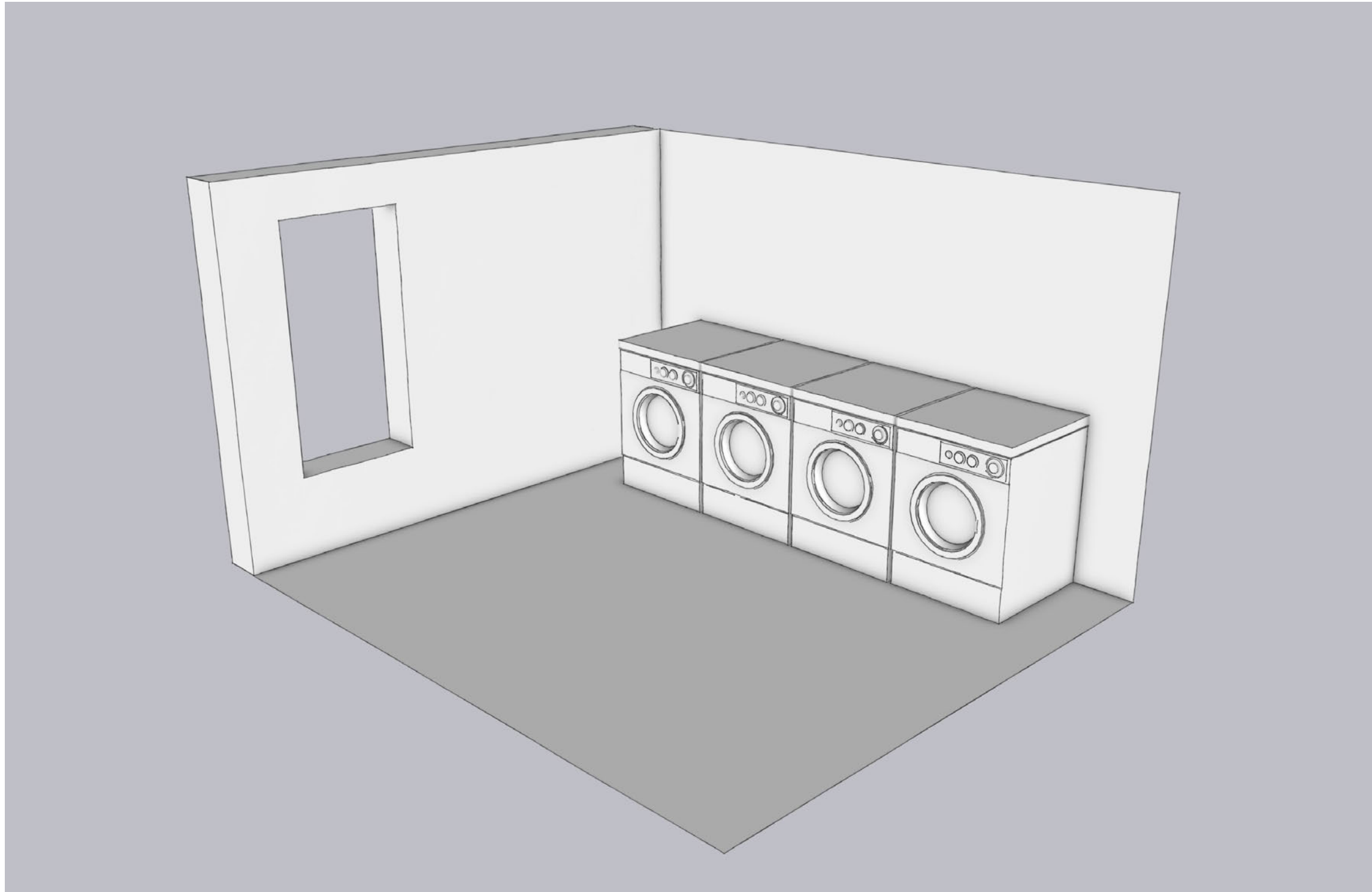

Dryers are not set up for easy control of supply air

Laundry Rooms

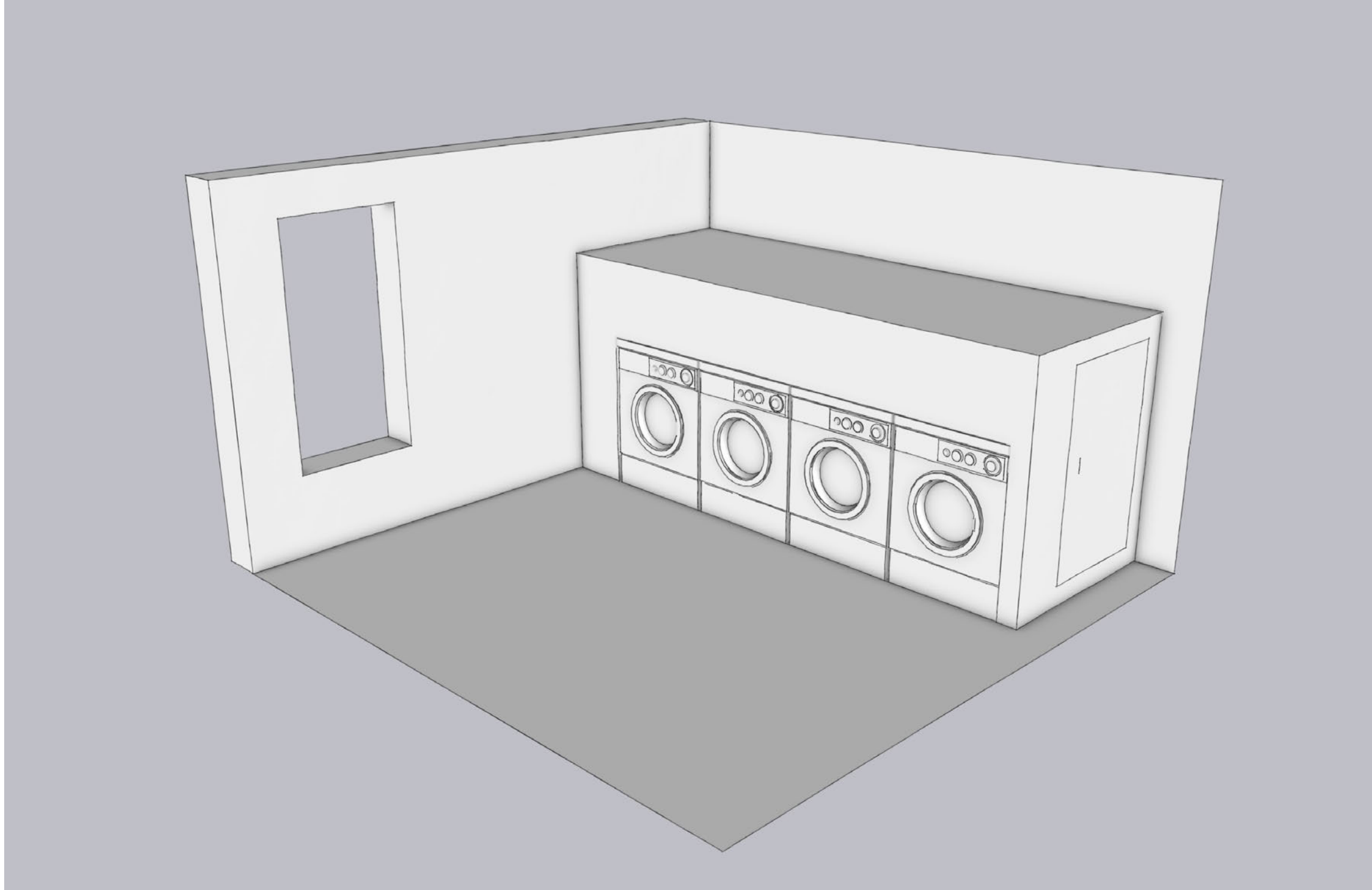

Plenums, or even full closets/rooms, that encase the equipment

Laundry Rooms

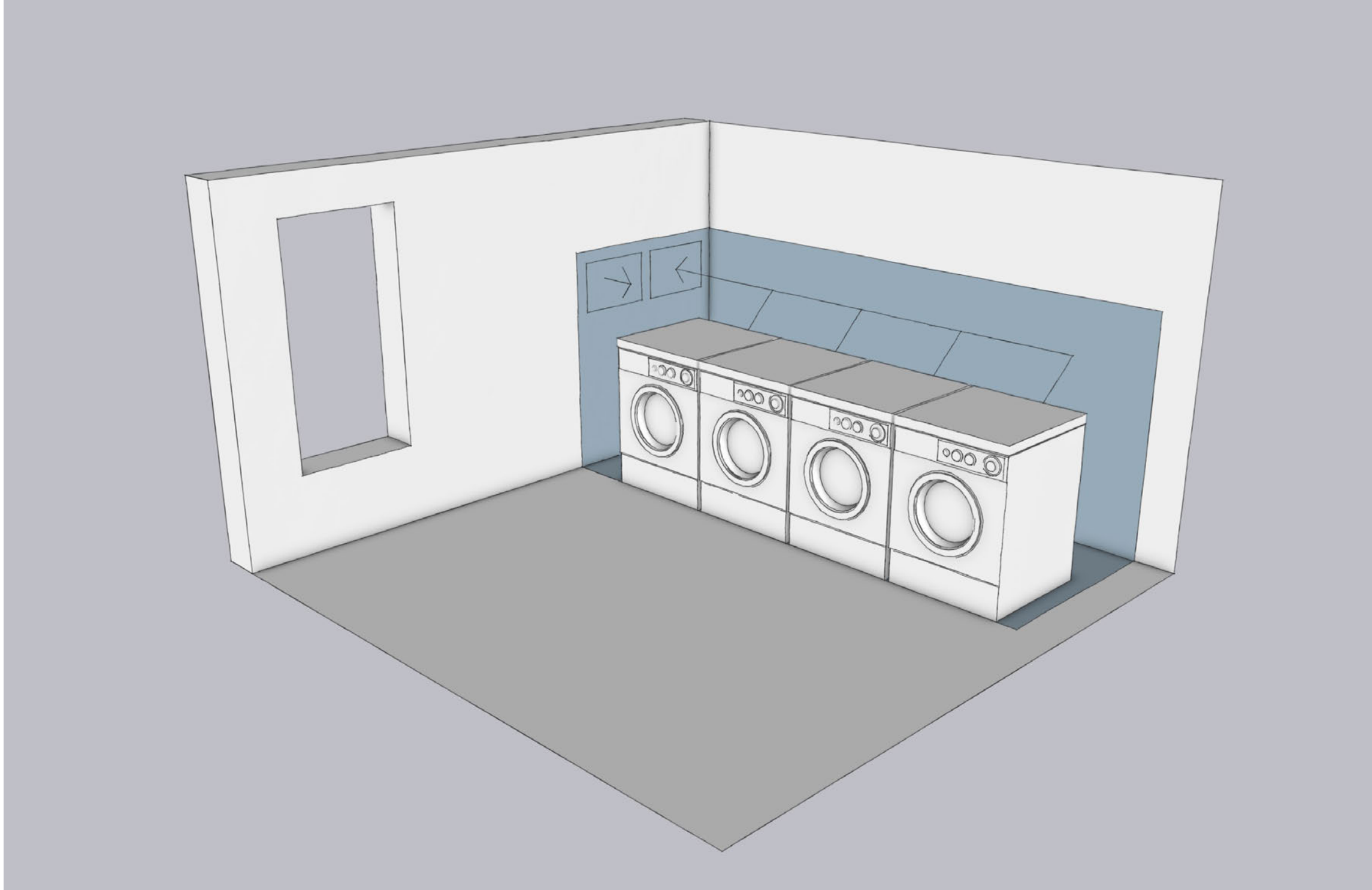

Phius is looking for details or schematic drawings that explain your approach

Envelope Airtightness

- **At the discretion of Phius**, sources of non-threatening air leakage* may be taped when testing to meet the airtightness criterion
 - *WUFI Passive* is used to model the building's performance, and must use the un-taped airtightness testing results
 - Carrying a placeholder envelope airtightness metric that includes a buffer can help avoid future headaches

*See Phius Certification Guidebook, Appendix F-2 (v3.2) for 2021 and Appendix C-2.3 (v24.1.1) for 2024

Modeling Contingencies

- Keeping geometry of spaces being considered for inclusion within the PH boundary lets the team toggle between the options available
 - Need to carefully track differences in iCFA and envelope area; usually not enough to change performance criteria, but will affect performance results

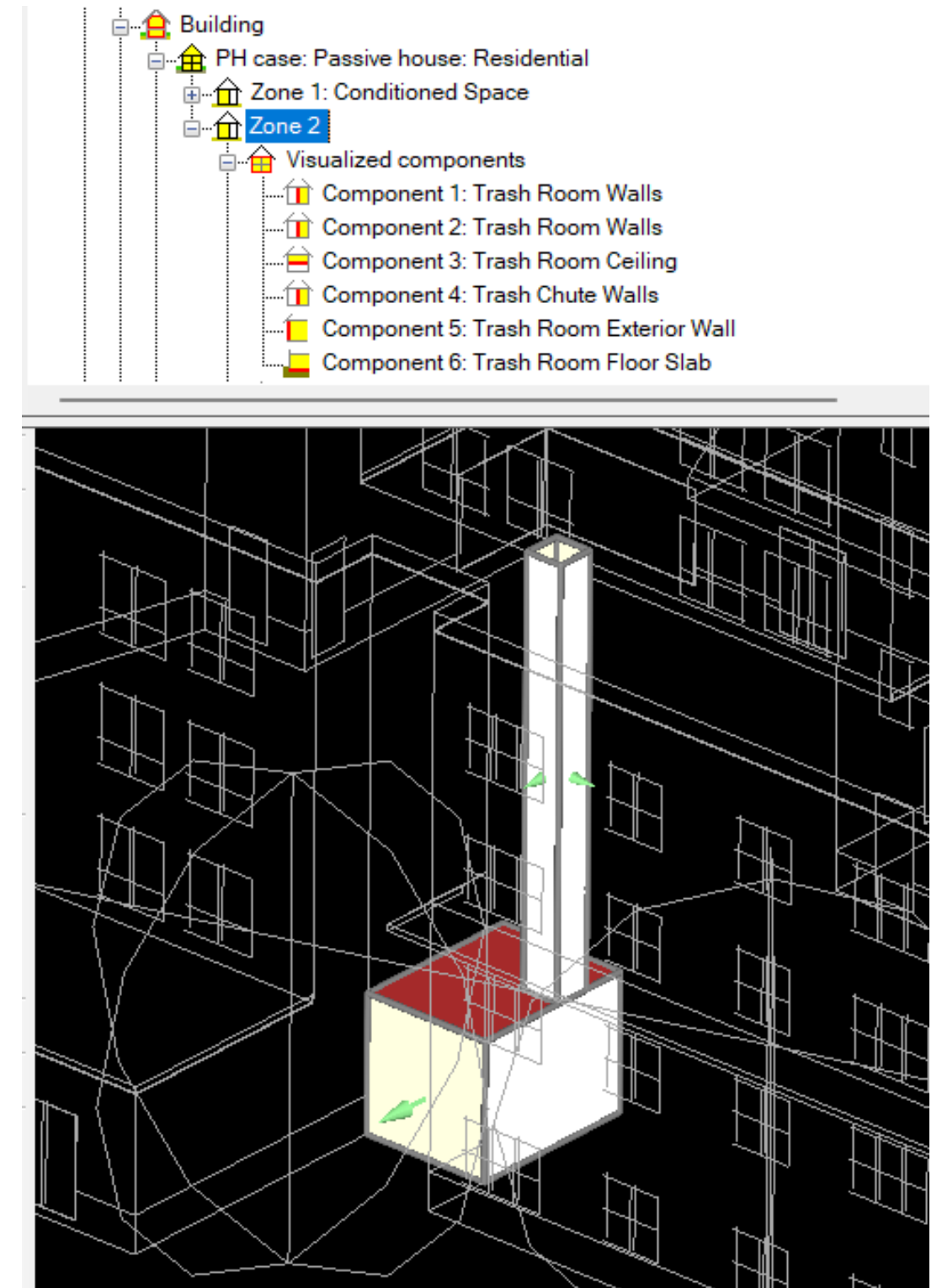

Thank you!

konieczny@newecology.org

parkinson@utiledesign.com

dperez@thorntontomasetti.com